

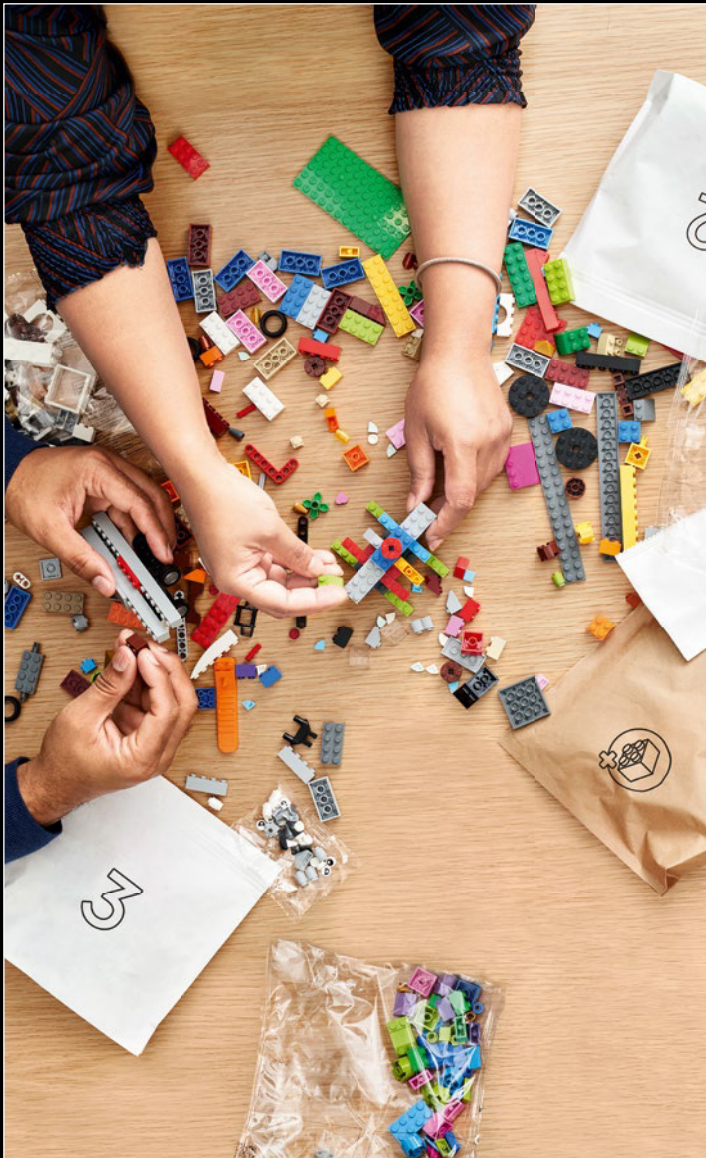

Booklet available in English on
Livret disponible en français sur
Folleto disponible en español en



WE'RE MAKING OUR PACKAGING MORE SUSTAINABLE

We're transitioning from single-use plastic to paper-based packaging. As we progress, you may find a mix of paper and plastic in our boxes.

NOUS RENDONS NOS EMBALLAGES PLUS DURABLES

Nous passons des emballages en plastique à usage unique aux emballages à base de papier. Durant la transition, vous pourriez trouver un mélange de papier et de plastique dans nos boîtes.

QUEREMOS HACER MÁS SUSTENTABLES NUESTROS MATERIALES DE EMBALAJE

Estamos cambiando las bolsas de plástico desechables por bolsas con base de papel. Conforme avanzamos en este propósito, puedes encontrar una mezcla de papel y de plástico en nuestras cajas.

LEGO.com/sustainable-packaging

LEGO® VIP

- 1.** SIGN UP
INSCRIVEZ-VOUS
REGÍSTRATE



- 2.** EARN POINTS FOR
PURCHASES

GAGNEZ DES POINTS
POUR VOS ACHATS
GANA PUNTOS POR
TUS COMPRAS

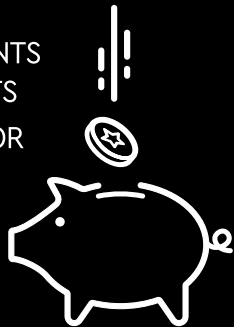

- 3.** REDEEM POINTS FOR REWARDS,
EXPERIENCES, DISCOUNTS & MORE
ÉCHANGEZ DES POINTS CONTRE DES
RÉCOMPENSES, DES EXPÉRIENCES,
DES RÉDUCTIONS ET PLUS ENCORE
CANJEA PUNTOS POR RECOMPENSAS,
EXPERIENCIAS, DESCUENTOS Y
MUCHO MÁS

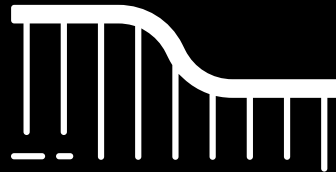
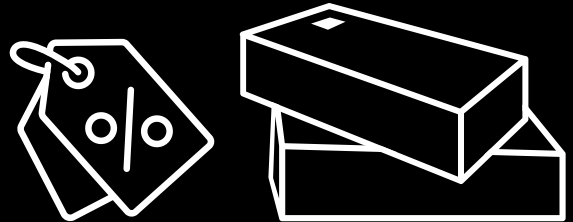

LEGOLAND®





Hold on to your doubloons!

Calling all imperial guards – the pirates are back! This LEGO® Icons set pays tribute to an all-time fan favorite, the 6276 Eldorado Fortress from 1989. The original set brought pirate adventures to life for those looking to set sail on the high seas in pursuit of bounteous treasure. Decades later, the model is still a much-loved collector's item. We can't even imagine all the stories these characters have played out in kids' rooms ever since!

Today, the new Eldorado Fortress is a thriving port with a new governor and a regiment of trusty imperial guards. They're as prepared as ever to protect their tropical paradise from plundering pirates. From the deepest dungeons to the top of the main tower, the fortress is a treasure trove of mysteries and stories to be discovered. Hoist your anchors, set sail and follow your compass to new adventures.



Tenez bien vos doubloons !

Appel à tous les gardes impériaux – les pirates sont de retour ! Cet ensemble LEGO® Icons rend hommage à l'un des plus grands favoris des amateurs, l'ensemble 6276 La forteresse Eldorado de 1989. L'ensemble original a donné vie à des aventures de pirates pour ceux qui souhaitent naviguer en haute mer à la recherche d'un immense trésor. Des décennies plus tard, le modèle est toujours une pièce de collection très appréciée. Nous ne pouvons même pas imaginer toutes les histoires que ces personnages ont vécues dans les chambres d'enfants depuis lors !

Aujourd'hui, la nouvelle forteresse Eldorado est un port prospère avec un nouveau gouverneur et un régiment de fidèles gardes impériaux. Ils sont plus qu' jamais prêts à protéger leur paradis tropical des pirates pilliers. Des donjons les plus profonds au sommet de la tour principale, la forteresse est un trésor de mystères et d'histoires à découvrir. Levez vos ancres, mettez les voiles et suivez votre boussole vers de nouvelles aventures.

¡Guarda bien tus doblones!

¡Llamando a todos los guardias imperiales! ¡Los piratas están de regreso! Este set LEGO® Icons rinde homenaje a un favorito de los fans de todos los tiempos: Eldorado Fortress (6276) de 1989. El set original dio vida a las aventuras piratas de quienes anhelaban recorrer los siete mares en busca de fastuosos tesoros. Décadas más tarde, el modelo es aún un apreciado artículo de colección. ¡No podemos ni imaginar todas las historias que estos personajes han interpretado en las habitaciones de los peques desde entonces!

Hoy, el nuevo Eldorado Fortress se ha convertido en un floreciente puerto con un nuevo gobernador y un regimiento de fieles guardias imperiales mejor preparados que nunca para proteger su paraíso tropical de piratas saqueadores. Desde los calabozos de las profundidades subterráneas hasta el punto más alto de la torre principal, la fortaleza es un tesoro oculto lleno de misterios e historias por descubrir. Leva anclas, prepárate para zarpar y guíate por la brújula en un viaje rumbo a nuevas aventuras.





6276 Eldorado Fortress from 1989
 6276 La forteresse Eldorado de 1989
 Eldorado Fortress (6276) de 1989.



The Golden Sovereign

The original set included a pirate comic book called 'The Golden Medallion' / 'The Golden Sovereign' (6255), which chronicled the daring adventures of Governor Broadside and his friends and foes. The story took place on an idyllic island where the governor enjoyed a quiet life until a boisterous band of pirates showed up! The comic told the fun-filled story of Broadside's plans to keep the troublesome Captain Red Beard and his cowardly crew at bay.

Le souverain d'or

L'ensemble original comprenait une bande dessinée intitulée *Le médaillon d'or / Le souverain d'or* (6255), qui relatait les aventures audacieuses du gouverneur Broadside, de ses amis et de ses ennemis. L'histoire se déroule sur une île idyllique où le gouverneur mène une vie tranquille jusqu'à ce qu'une bande de pirates turbulents débarque ! Cette bande dessinée racontait l'histoire amusante des plans de Broadside pour tenir à distance le pénible capitaine Barbe-Rouge et son équipage de lâches.

The Golden Sovereign

El set original incluía un cómic de piratas titulado *The Golden Medallion/The Golden Sovereign* (6255), que describía las audaces aventuras del Gobernador Broadside y sus amigos y enemigos. La historia transcurría en una isla idílica, donde el gobernador disfrutaba de una vida tranquila... ¡hasta que apareció una banda de alborotadores piratas! El cómic relataba las divertidas peripecias de Broadside intentando mantener a raya al molesto Capitán Barbarroja y su cobarde tripulación.



Then and now

Back in the day, Eldorado Fortress was always a bit of a mystery. What was inside? How did the pirates keep escaping from the clink? What treasures were the Governor's imperial guards watching over? Well, all the secrets of the Eldorado are about to be revealed. Every corner you turn, there's a new story to build. Designed as a modular set, the model opens up so you can peek inside and rearrange the fortress as much as you'd like.

Hier et aujourd'hui

À l'époque, la forteresse Eldorado était toujours un peu mystérieuse. Qu'y avait-il à l'intérieur? Comment les pirates parvenaient-ils à s'échapper de la prison? Sur quels trésors les gardes impériaux du gouverneur veillaient-ils? Eh bien, tous les secrets de l'Eldorado sont sur le point d'être révélés. À chaque tournant, il y a une nouvelle histoire à construire, et ce, comme un ensemble modulaire, le modèle s'ouvre pour permettre de regarder à l'intérieur et de réorganiser la forteresse à volonté.

Entonces y ahora

En aquellos tiempos, la fortaleza del set Eldorado Fortress siempre estuvo rodeada de un pequeño halo de misterio. ¿Qué contenía? ¿Cómo lograban los piratas escapar de prisión una y otra vez? ¿Qué tesoros custodiaban los guardias imperiales del gobernador? Pues bien, todos esos secretos de Eldorado están a punto de revelarse. A la vuelta de cada esquina hay una nueva historia esperando que la construyas. Diseñado como set modular, el modelo se abre para que puedas curiosear en su interior y reorganizar la fortaleza tanto como quieras.



Spot the differences

The model design brings back all the charm of the original set and includes clues to the many stories that have taken place here over the past 30 years. See if you can spot the details that will remind you of the original set and uncover the updated features, functions and minifigures.

Repérez les différences

Le modèle évoque tout le charme de l'ensemble original et comprend des indices sur les nombreuses histoires qui se sont déroulées ici au cours des 30 dernières années. Essayez de repérer les détails de l'ensemble original et découvrez les caractéristiques, fonctions et figurines modernisées.

Encuentra las diferencias

El diseño del modelo recupera todo el encanto del set original e incluye pistas de las numerosas historias acontecidas aquí durante los últimos 30 años. Mira si puedes encontrar los detalles que te recordarán el set original y descubre las características, funciones y minifiguras actualizadas.

The original Eldorado Fortress included two row boats that have been replaced in this set by the more modern ship that came with set 6277 in 1992.

La forteresse Eldorado originale comprenait deux chaloupes qui ont été remplacées dans cet ensemble par le navire plus moderne compris dans l'ensemble 6277 en 1992.

El set Eldorado Fortress original incluía dos botes, sustituidos en este set por la embarcación, más moderna, que venía en el set 6277 de 1992.



Time to continue the story

"The original model is a great design, and we know many adults who played with the set as kids still feel a tremendous fondness for it. We're extremely excited to invite you back for an action-packed reunion! Over the past few decades, some areas of the fortress have clearly been changed by wear, tear and perhaps occasional encounters with pirates. Other areas have been modernized to suit the needs of modern travelers and to help the governor keep those troublesome pirates at bay. I hope this updated rendition brings back the best memories and creates amazing new ones!"

Pierre Normandin - LEGO® Icons Senior Designer

Il est temps de continuer l'histoire

« Le modèle original présente une superbe conception, et nous savons que de nombreux adultes qui ont joué avec l'ensemble lorsqu'ils étaient enfants ont encore beaucoup d'affection pour lui. Nous sommes très heureux de vous inviter à des retrouvailles pleines d'action ! Au cours des dernières décennies, certaines parties de la forteresse ont clairement été altérées par l'usure et les visites occasionnelles des pirates. D'autres sections ont été modernisées pour répondre aux besoins des voyageurs modernes et pour aider le gouverneur à tenir les pirates à distance. J'espère que cette version actualisée vous rappellera de merveilleux souvenirs et en créera de nouveaux ! »

Pierre Normandin - Concepteur principal LEGO® Icons

Es la hora de continuar la historia

"El diseño del modelo original es fantástico, y tenemos constancia de que muchos adultos que jugaron con el set en su niñez siguen sintiendo muchísimo cariño por él. ¡Nos hace muy felices invitarte de nuevo a un encuentro lleno de acción! En las últimas décadas, ciertas partes de la fortaleza han sufrido cambios evidentes debidos al desgaste, el deterioro y, quizá, a algún tropiezo ocasional con piratas. Otras áreas se han modernizado para adecuarlas a las necesidades de los viajeros de nuestro tiempo y para ayudar al gobernador a mantener a raya a los fastidiosos piratas. ¡Espero que esta interpretación actualizada sirva para desempolvar los mejores recuerdos y crear otros nuevos increíbles!"

Pierre Normandin - Diseñador sènior de LEGO® Icons



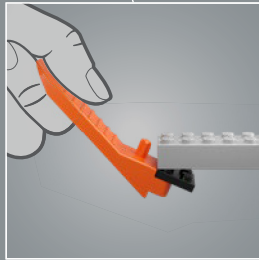
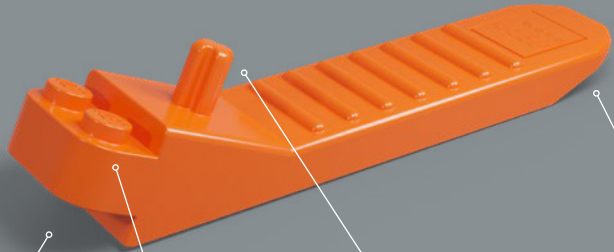

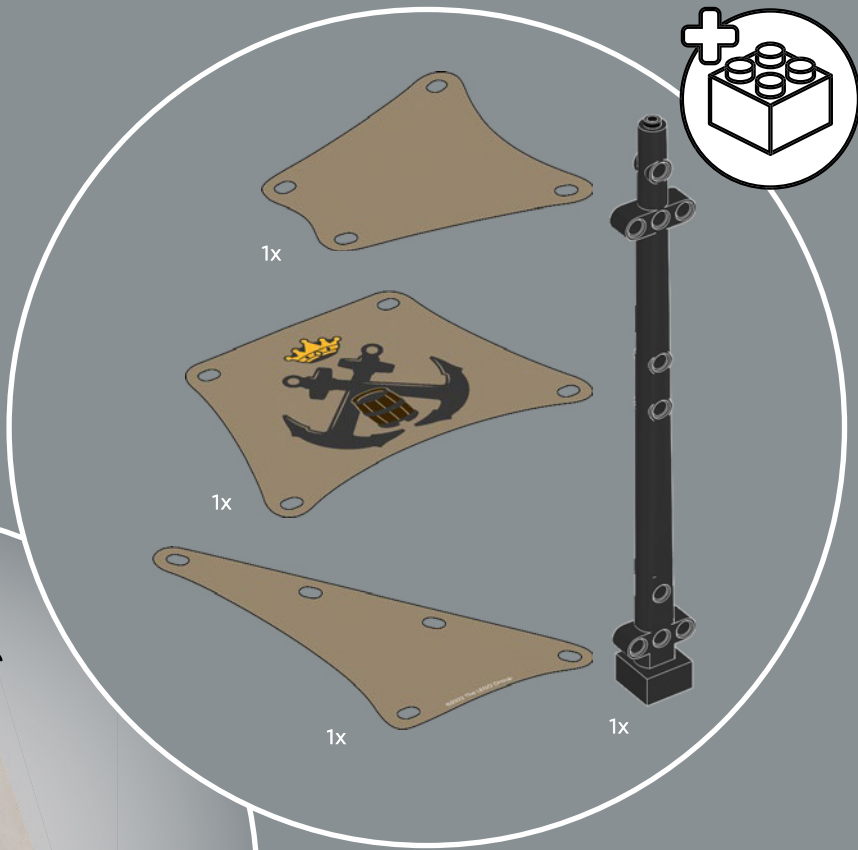

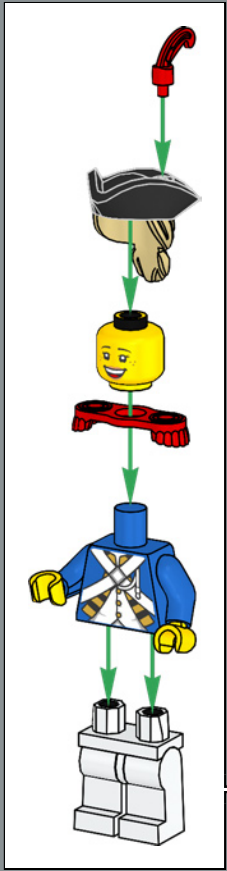

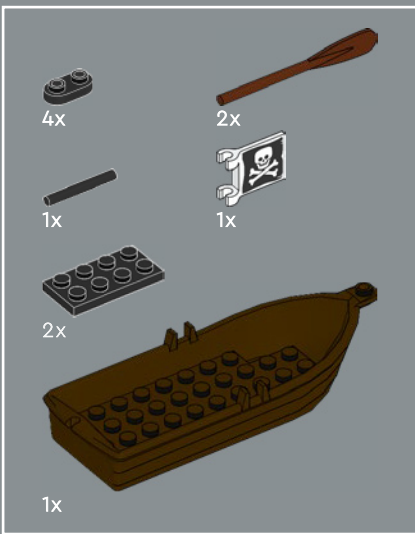

1

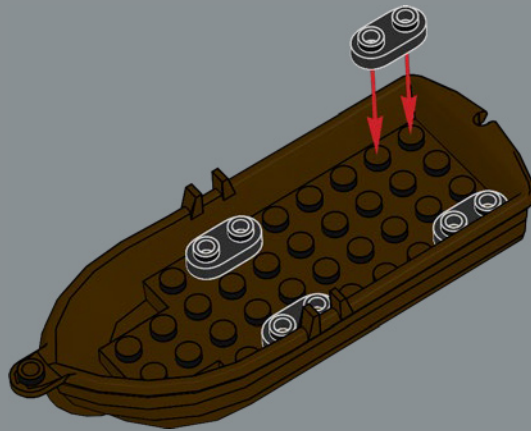

2

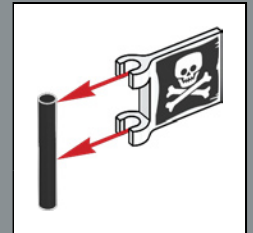
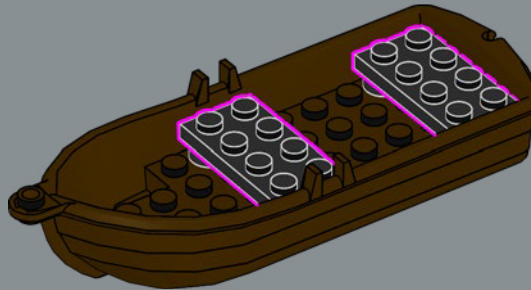

3

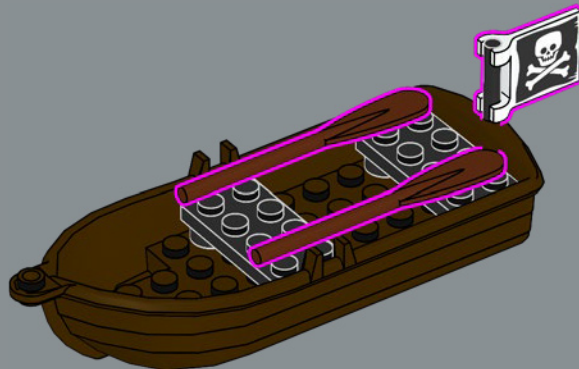

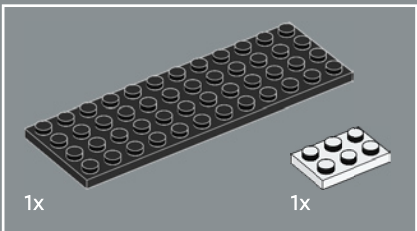
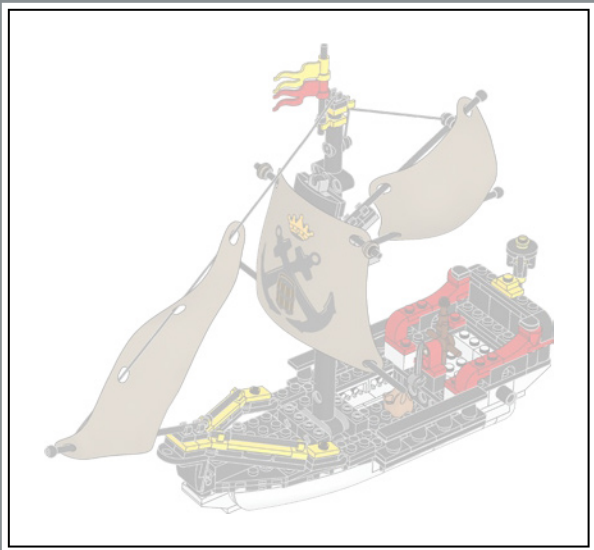

1

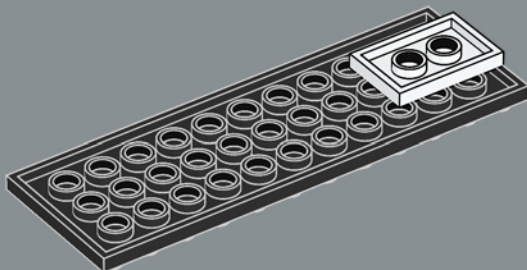

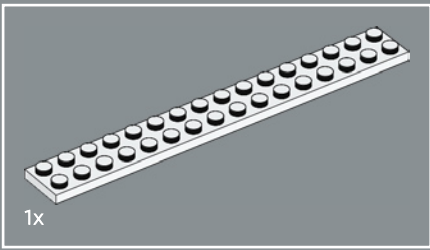

2

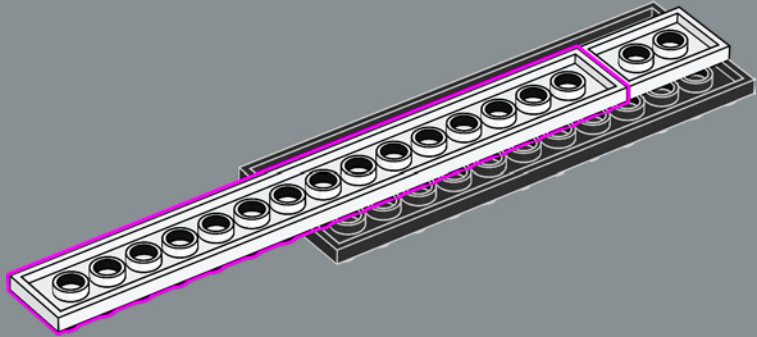

3

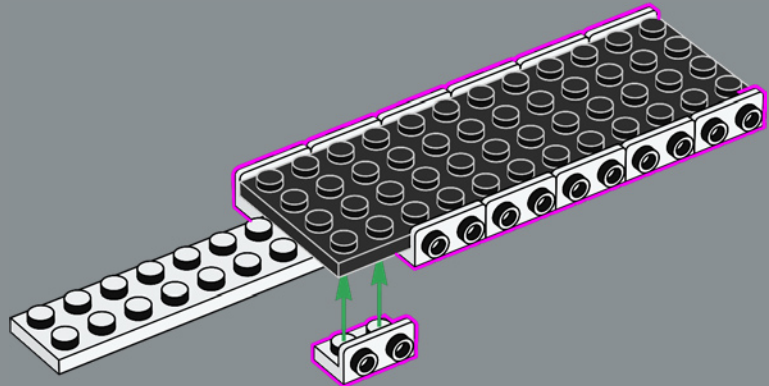

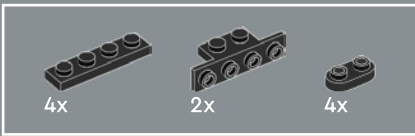

6

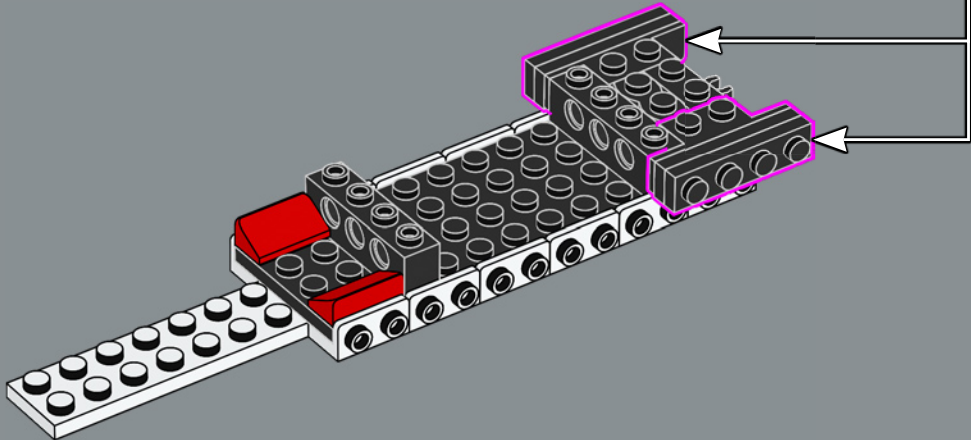
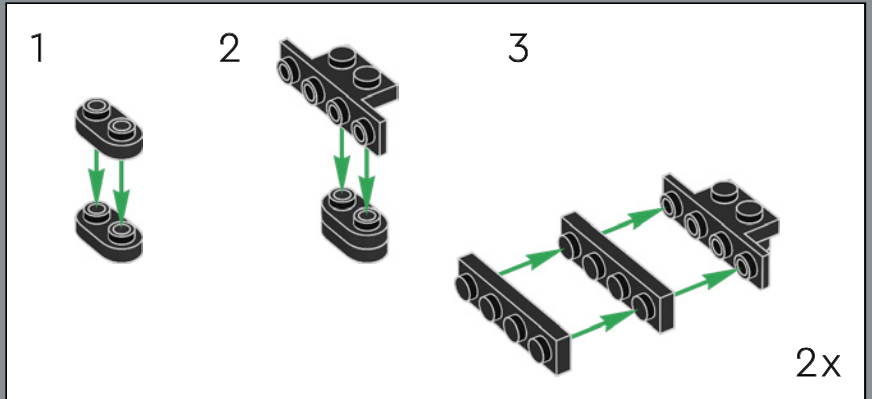

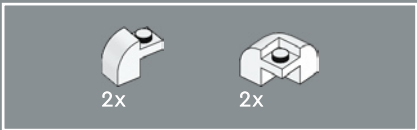

7

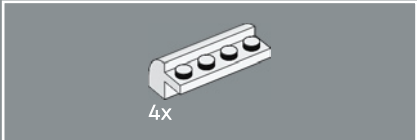
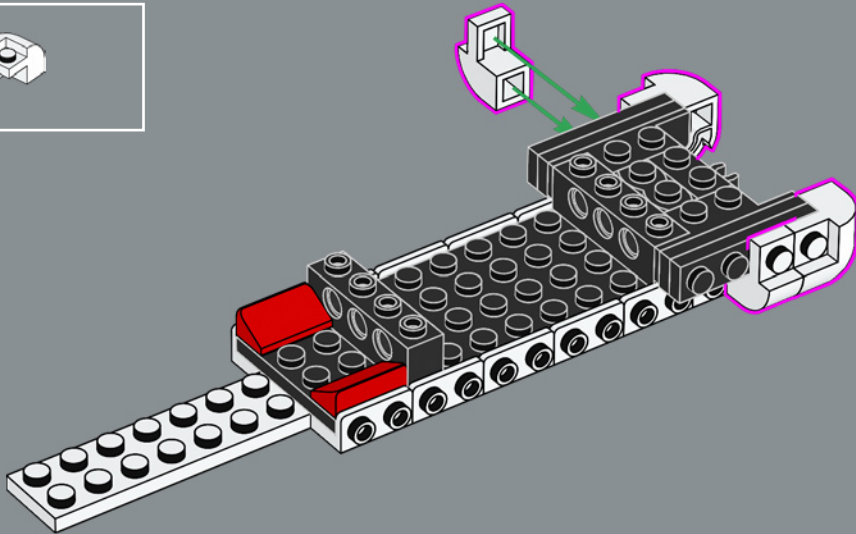

8

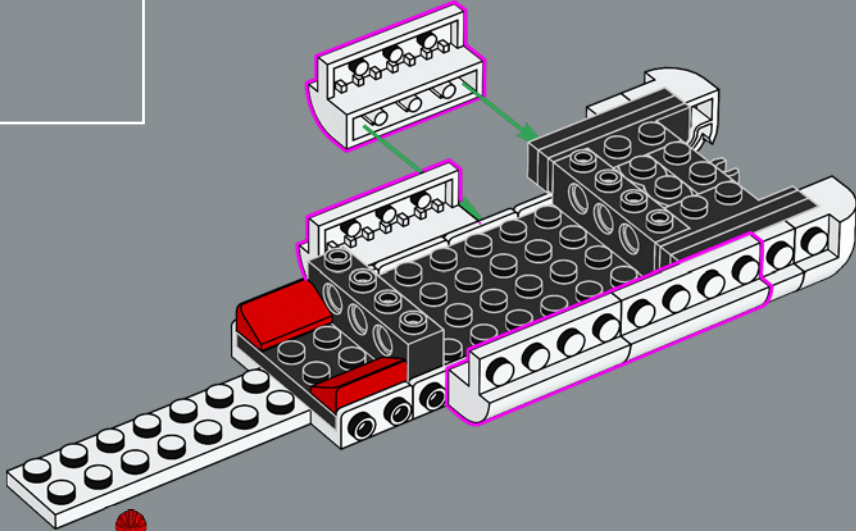

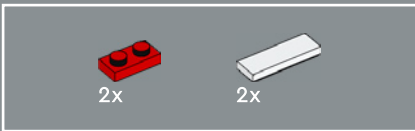

9

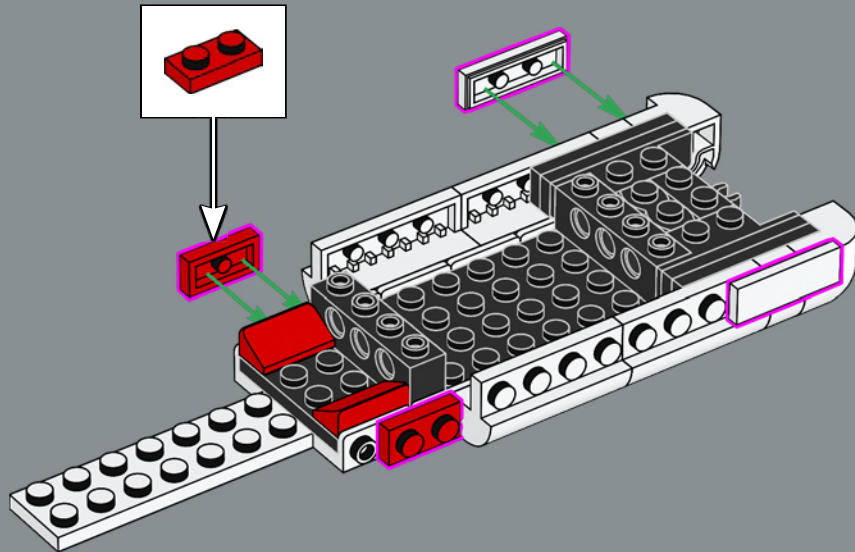

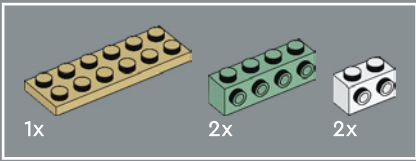

10

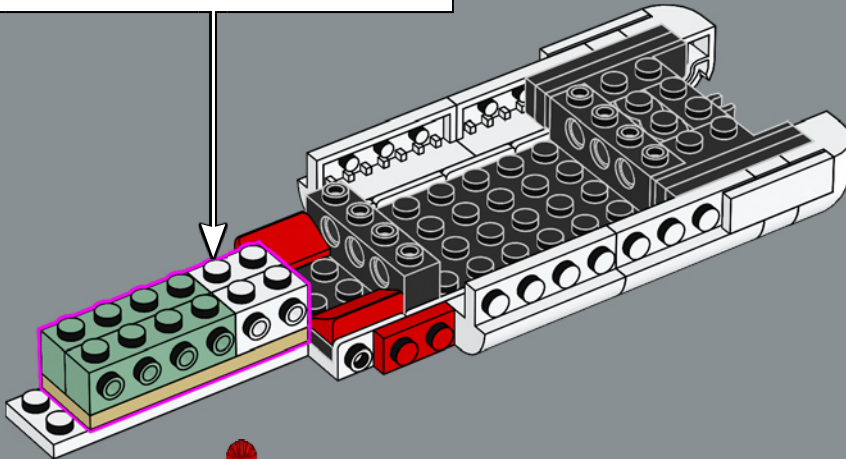
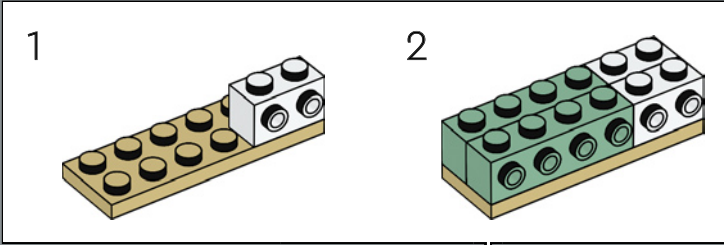

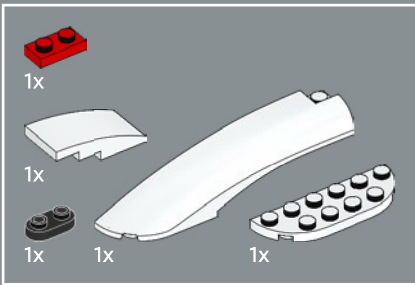

11

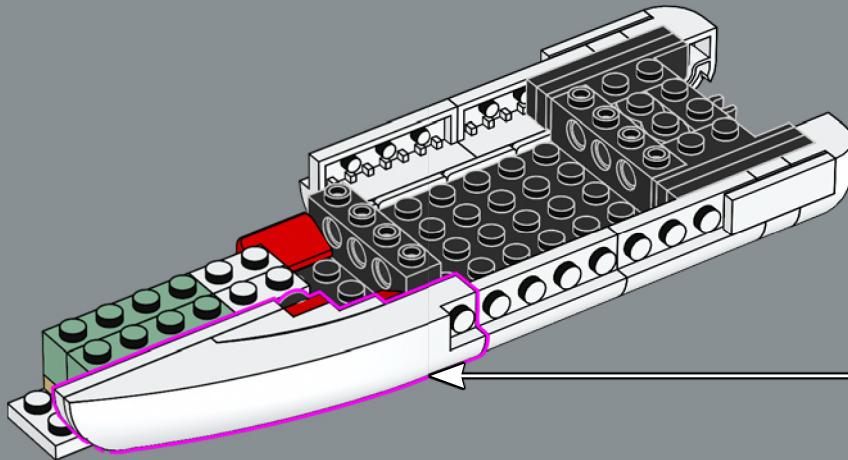
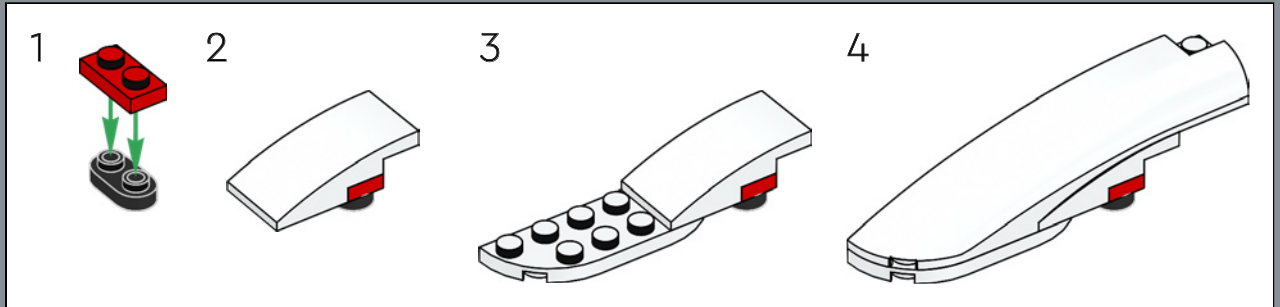

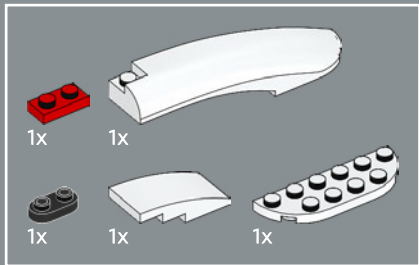

12

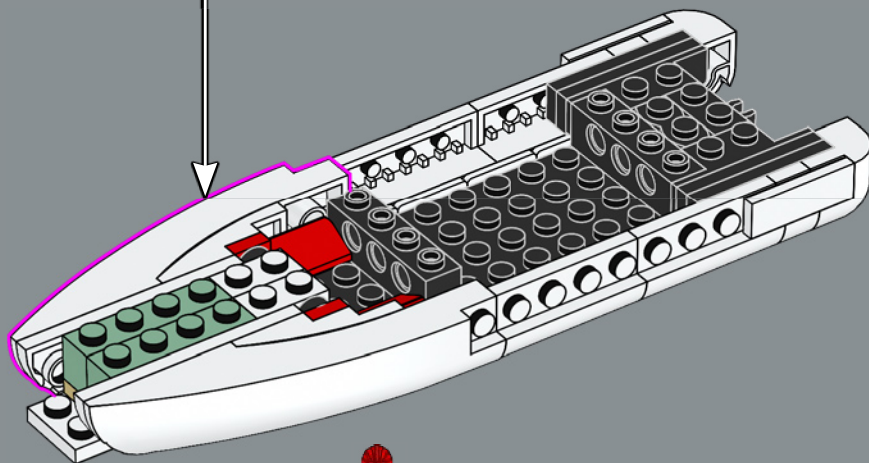
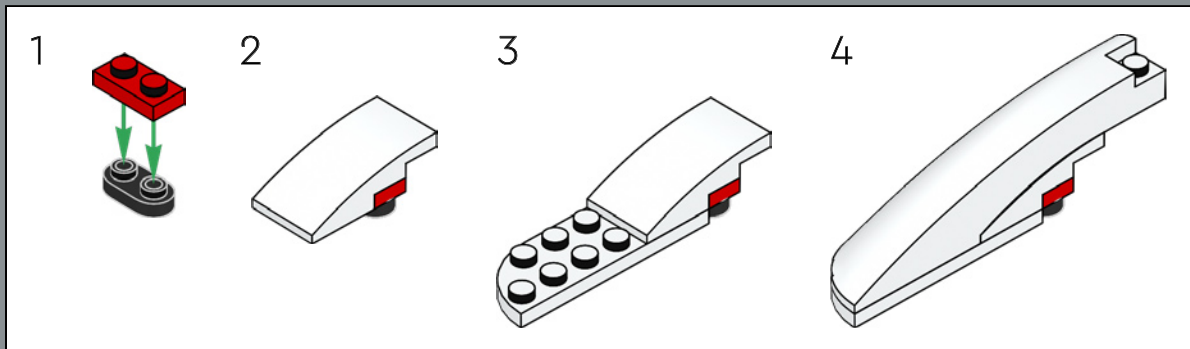



13

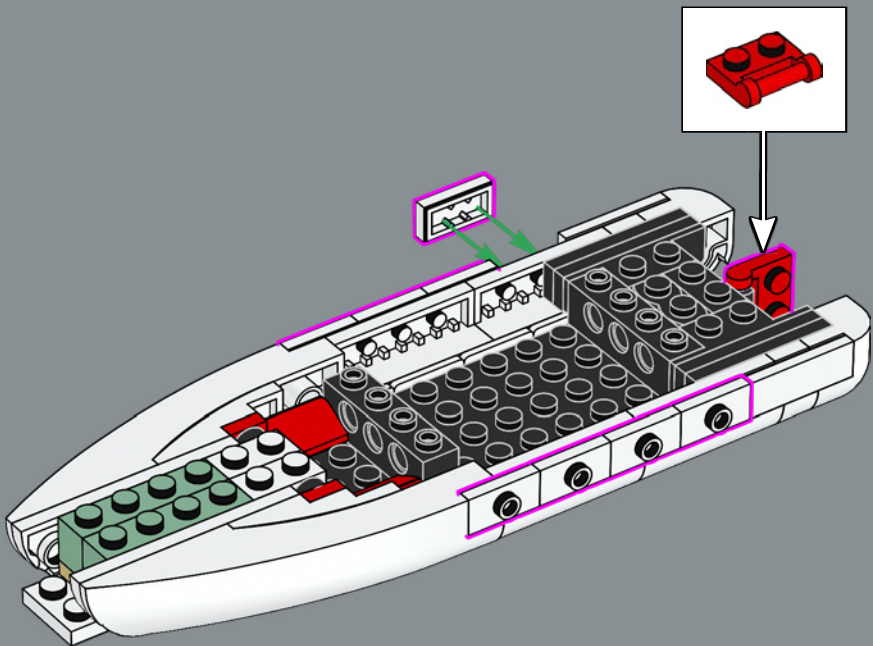
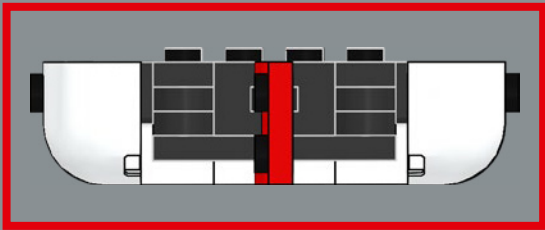

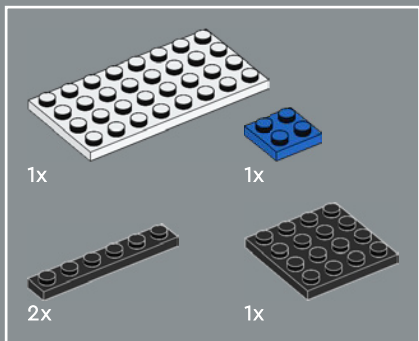

14

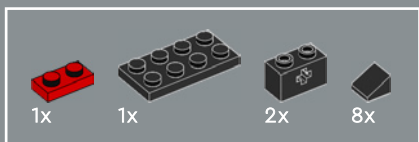
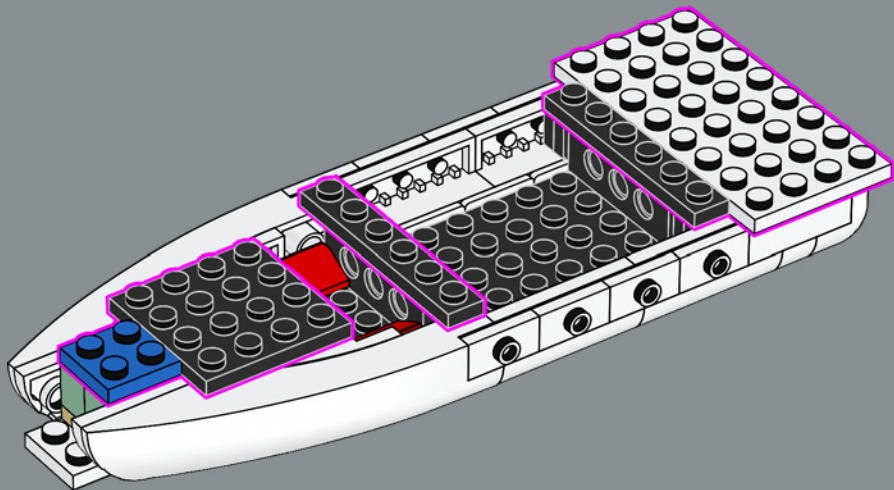

15

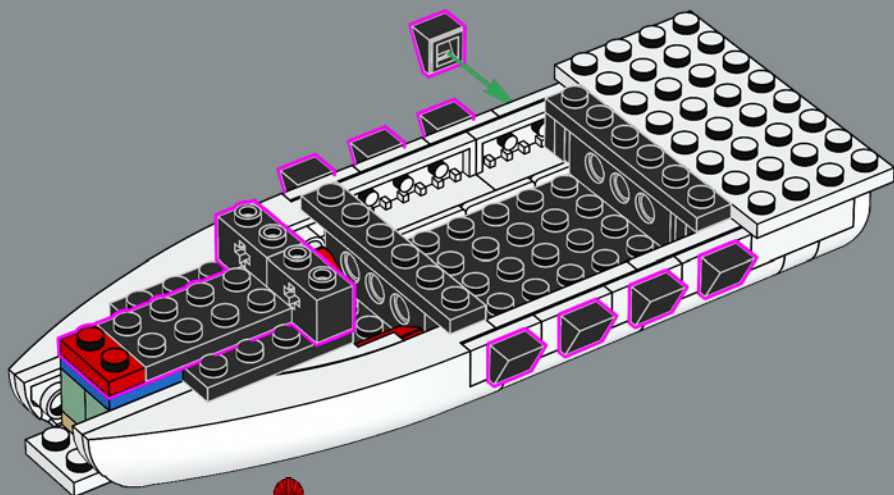

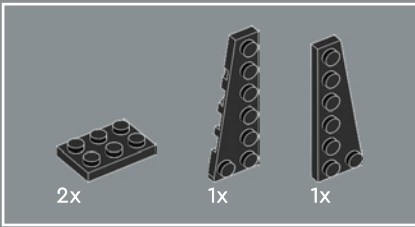

16

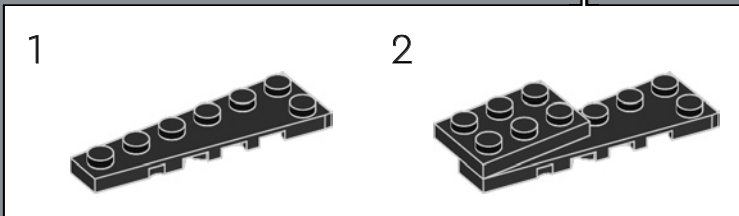
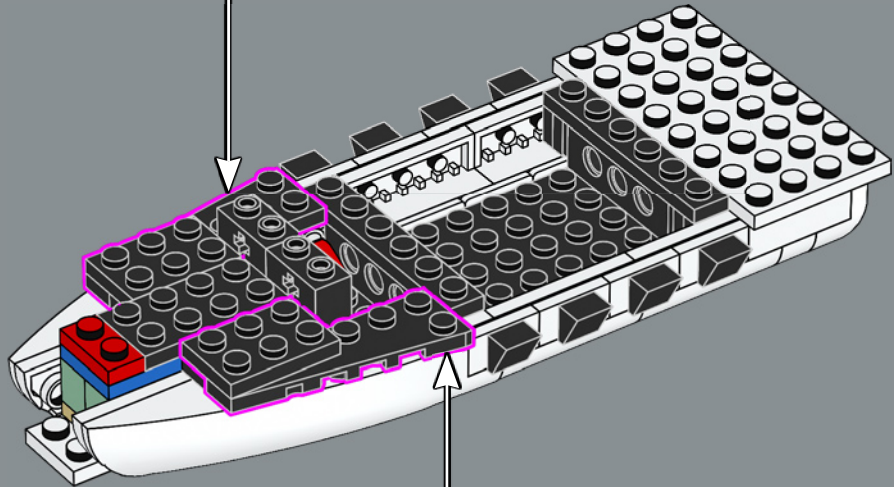
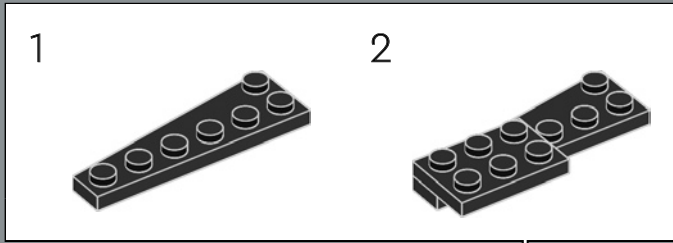

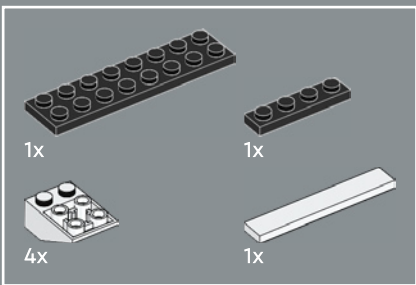

17

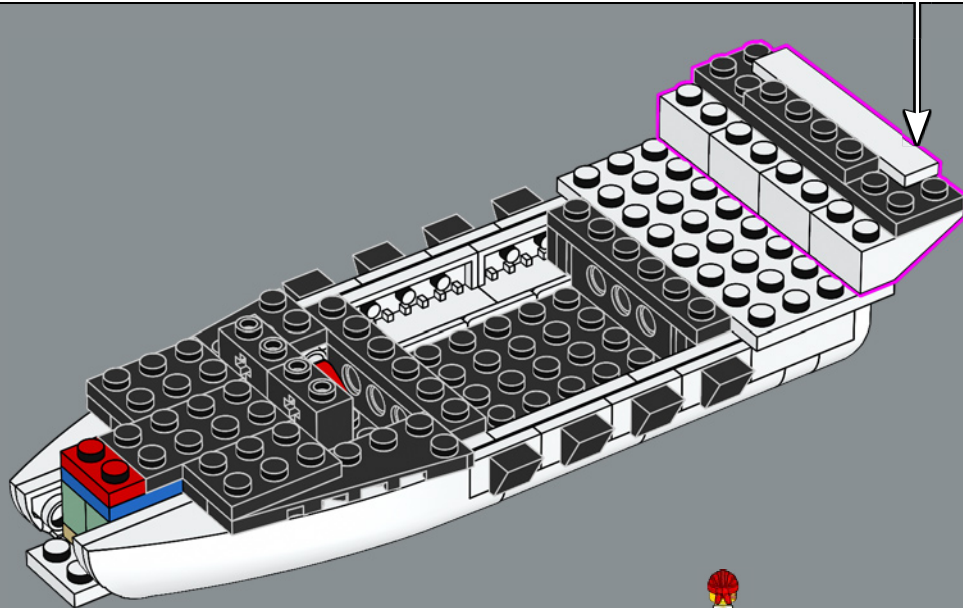
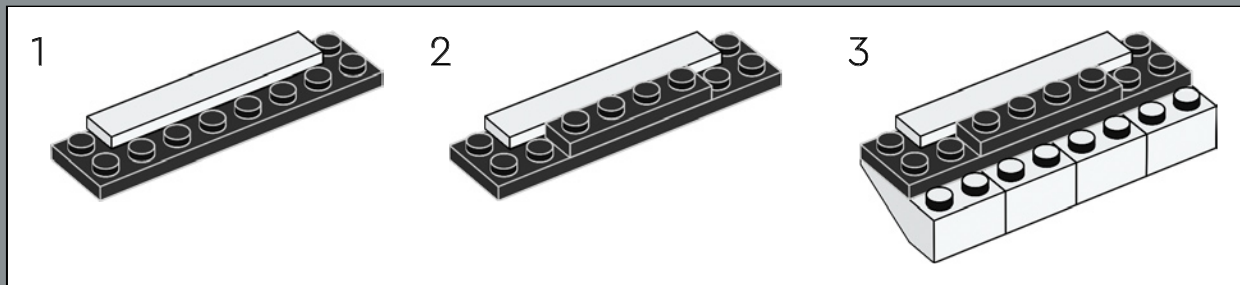

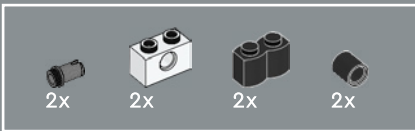

18

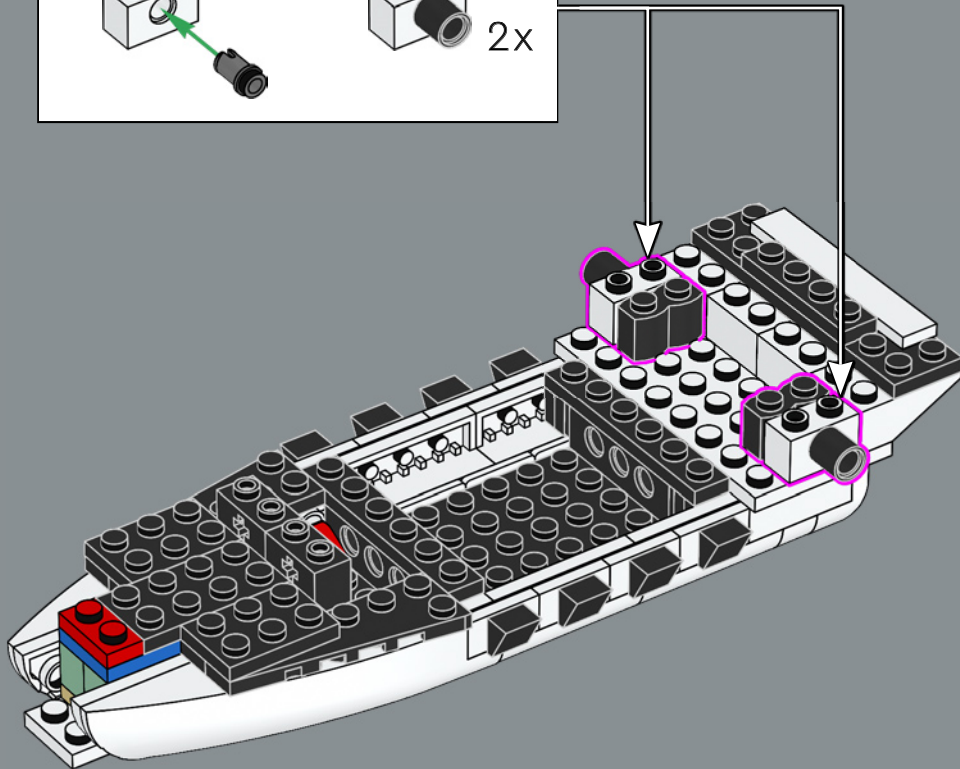
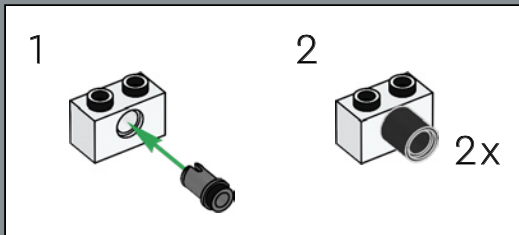

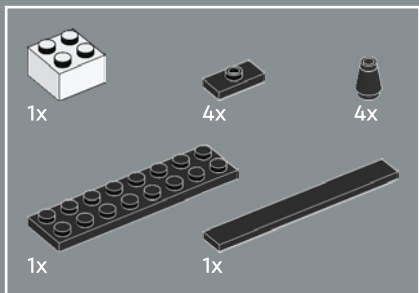

19

1

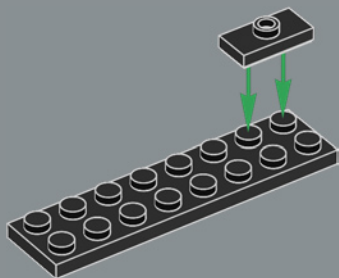

2

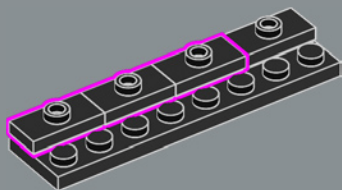

3

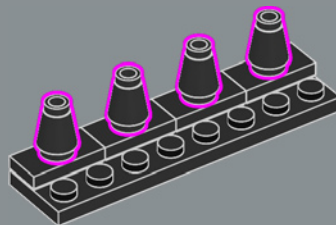

4

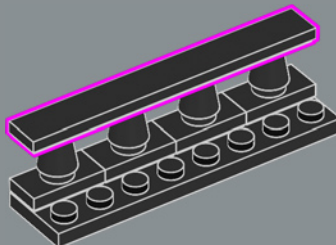

5

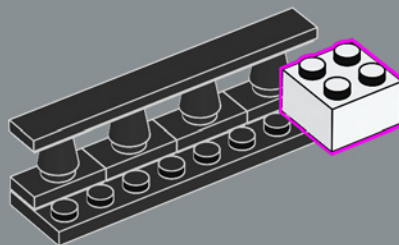

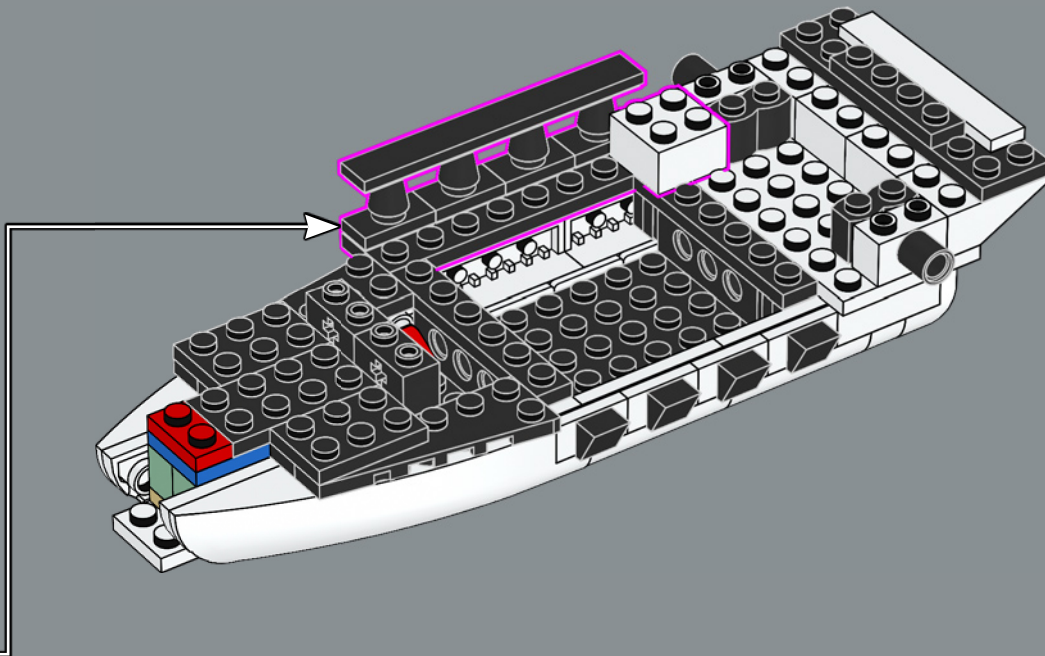

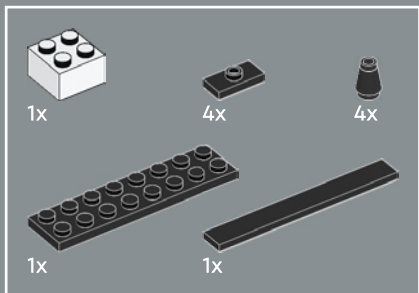

20

1

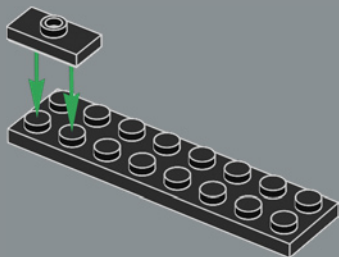

2

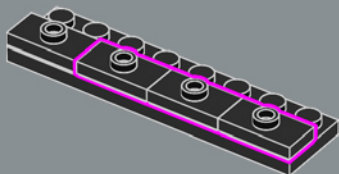

3

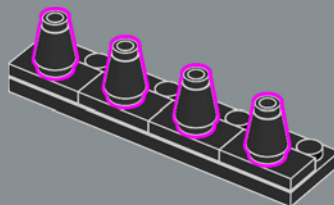

4

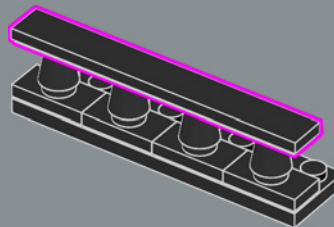

5

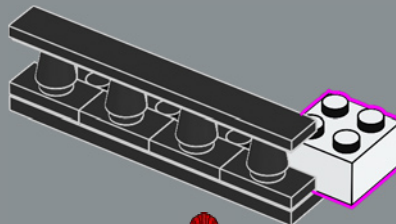

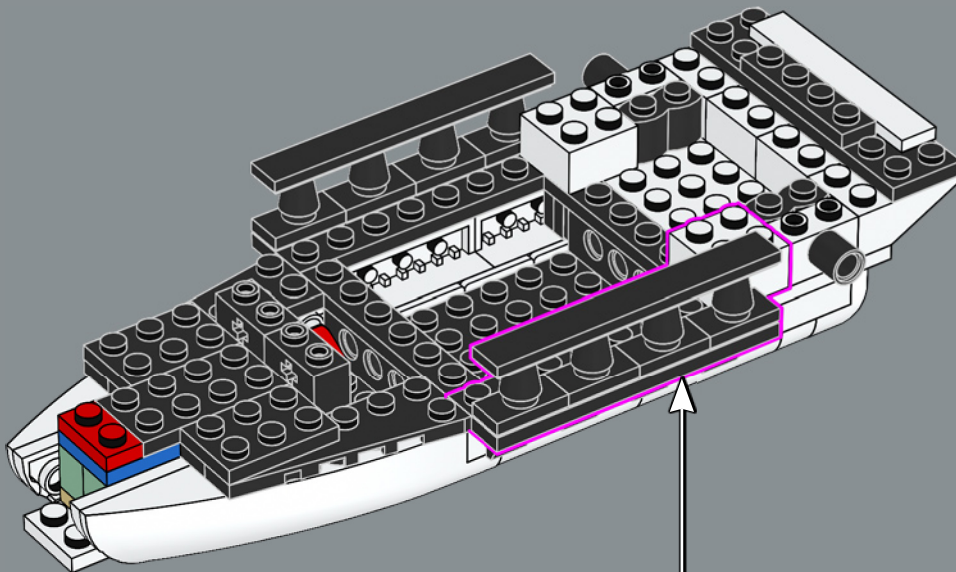

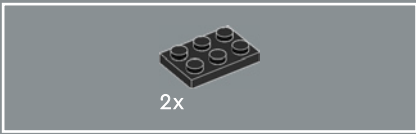

21

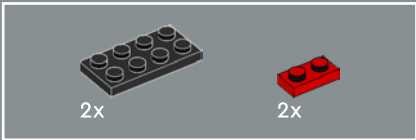
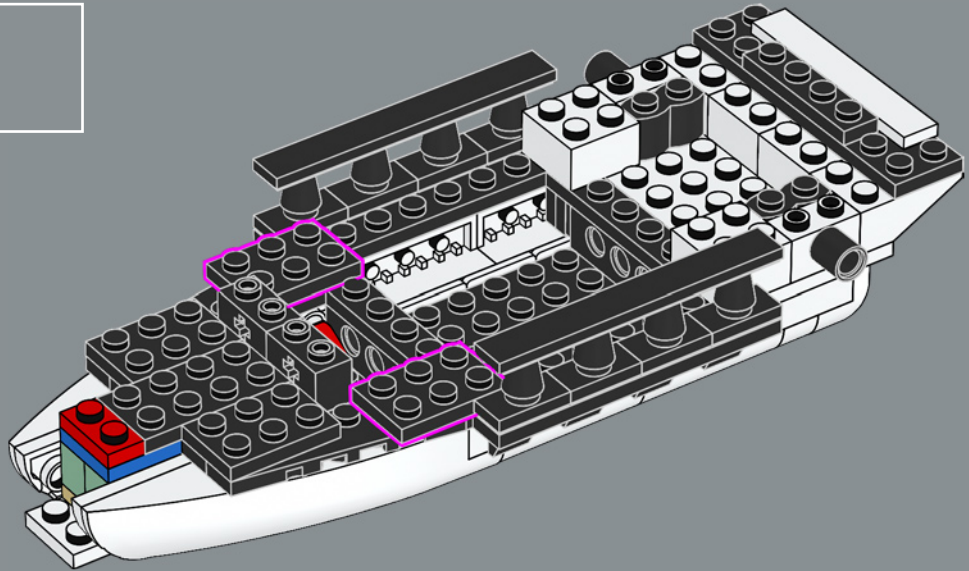

22

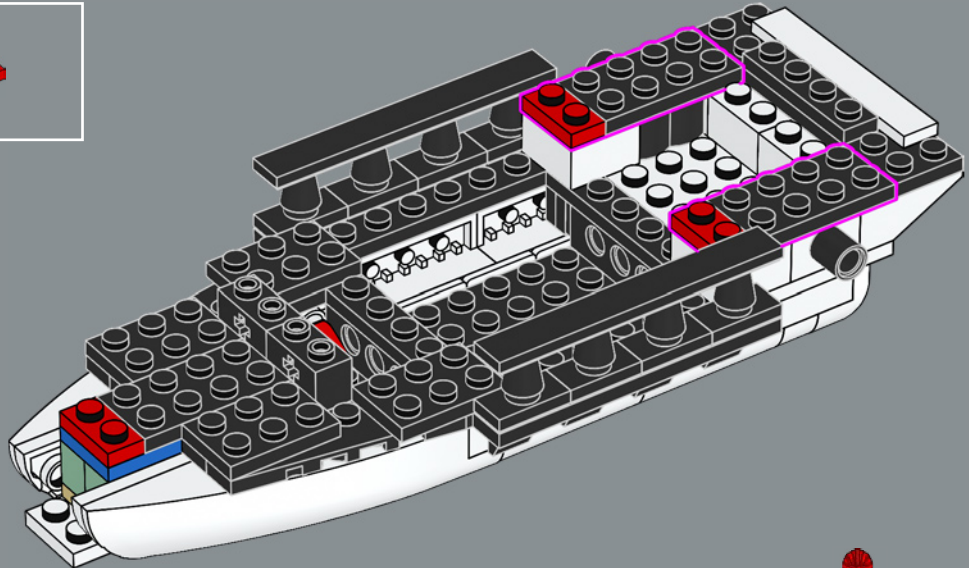

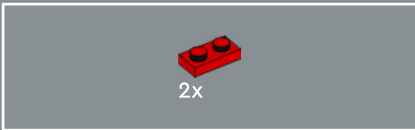

23

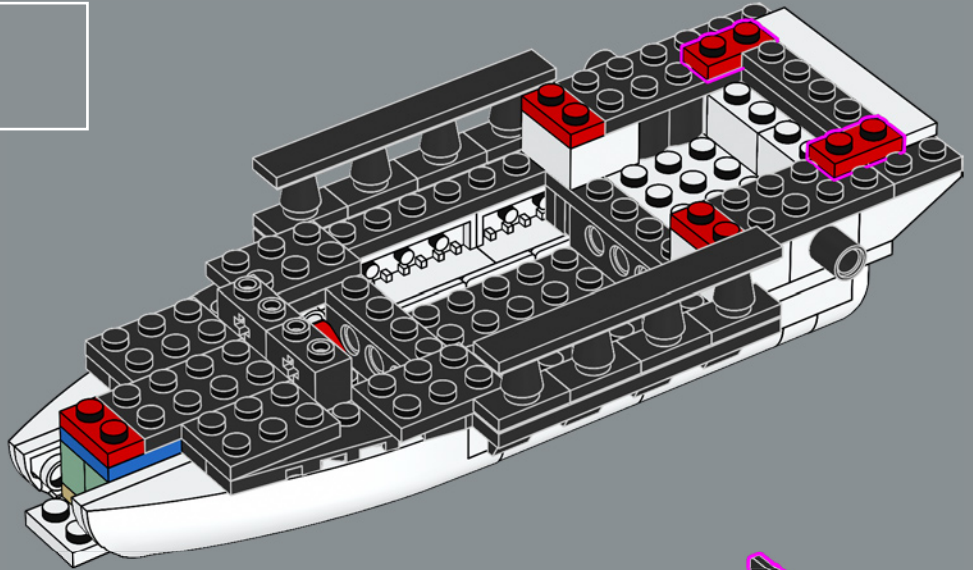

24

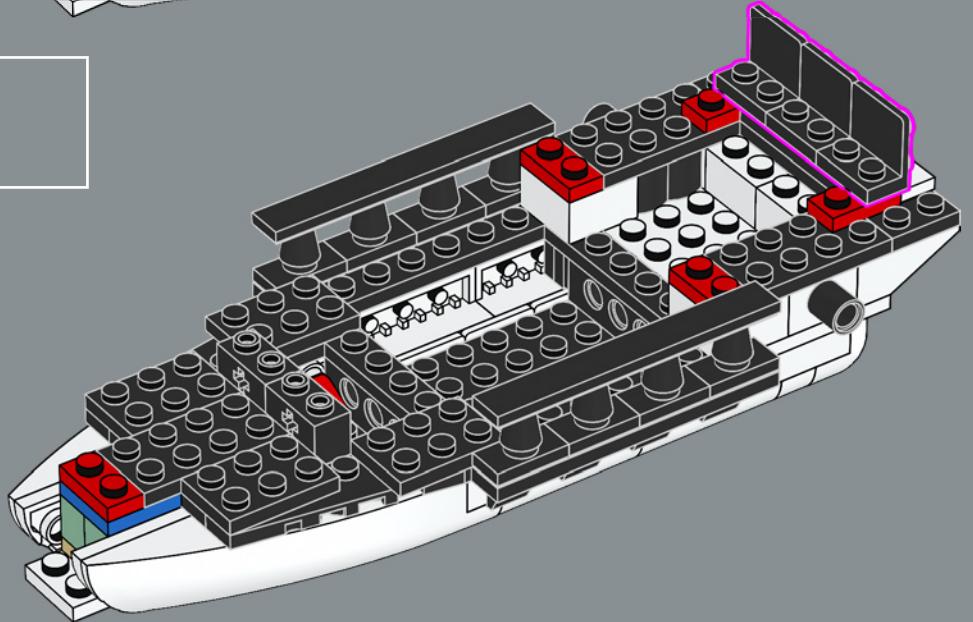

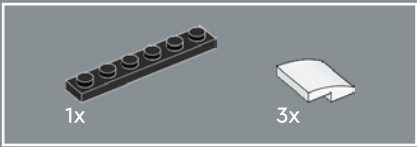

25

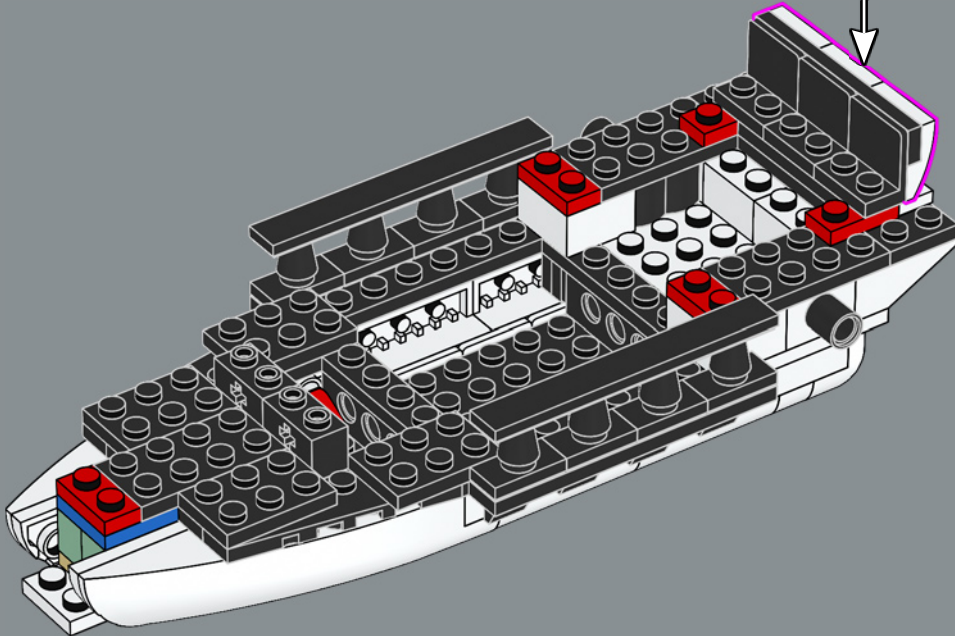
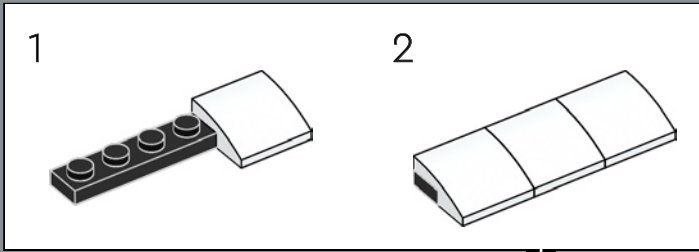

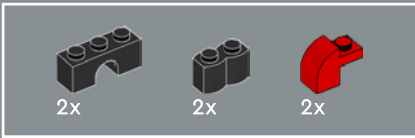

26

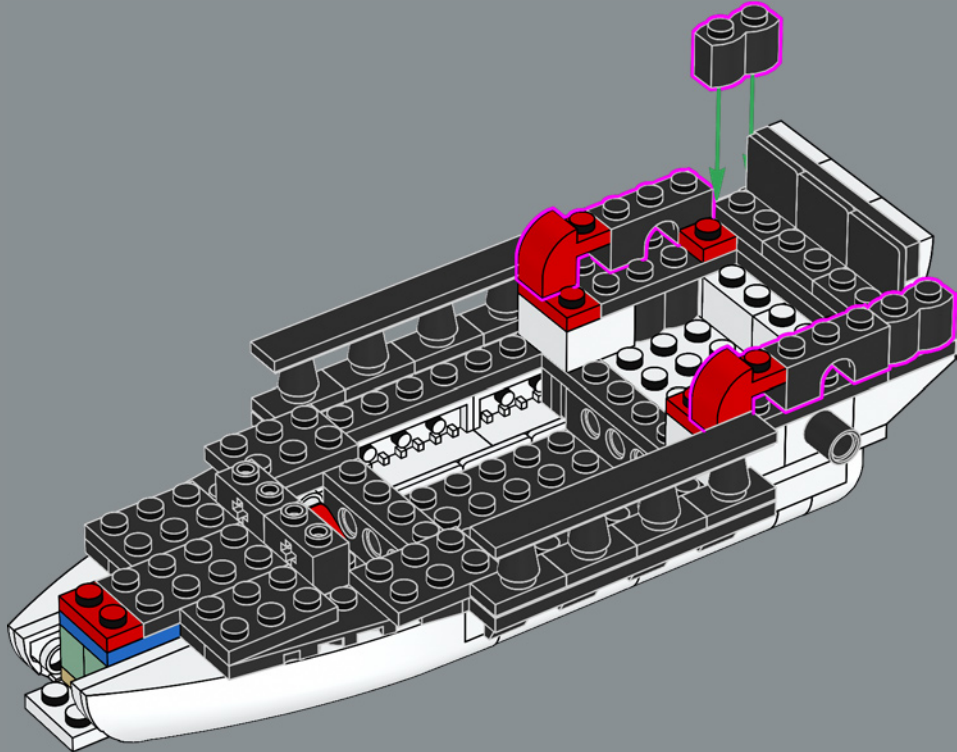

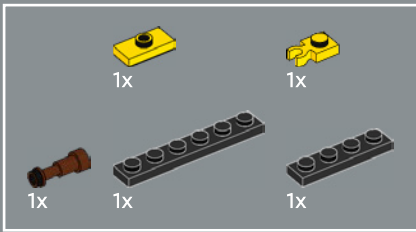

29

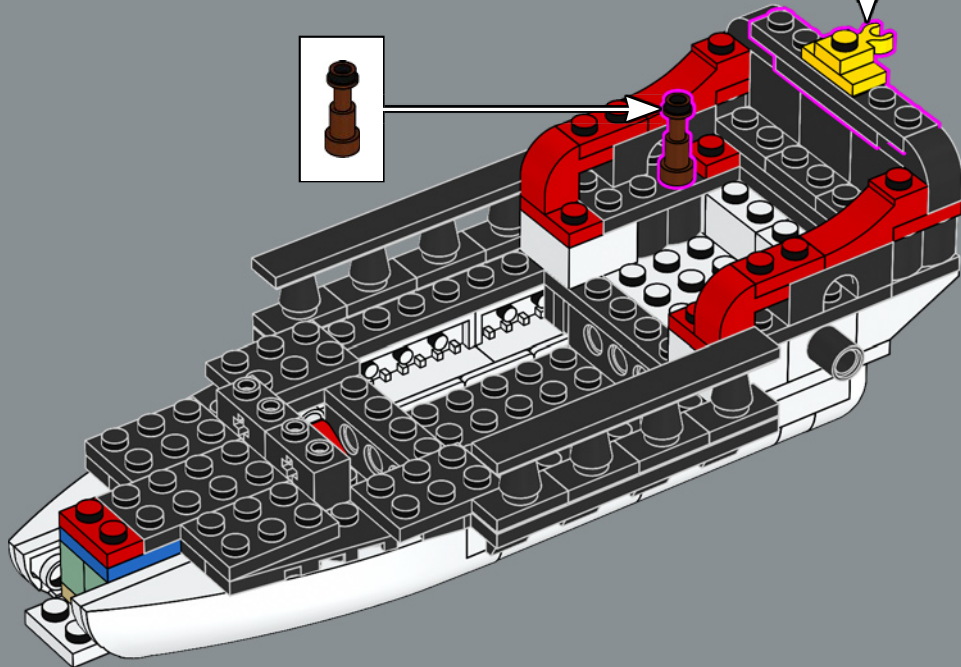
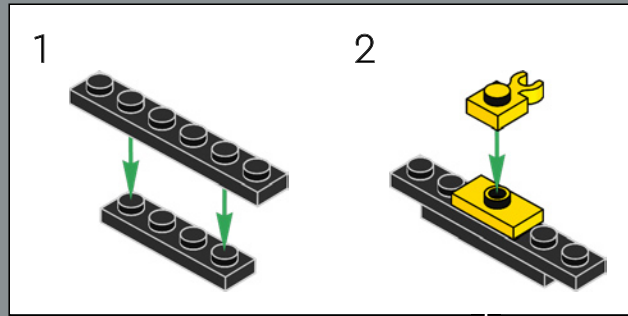

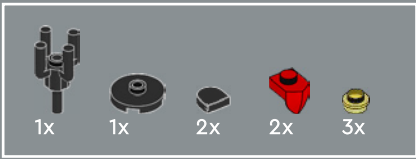

30

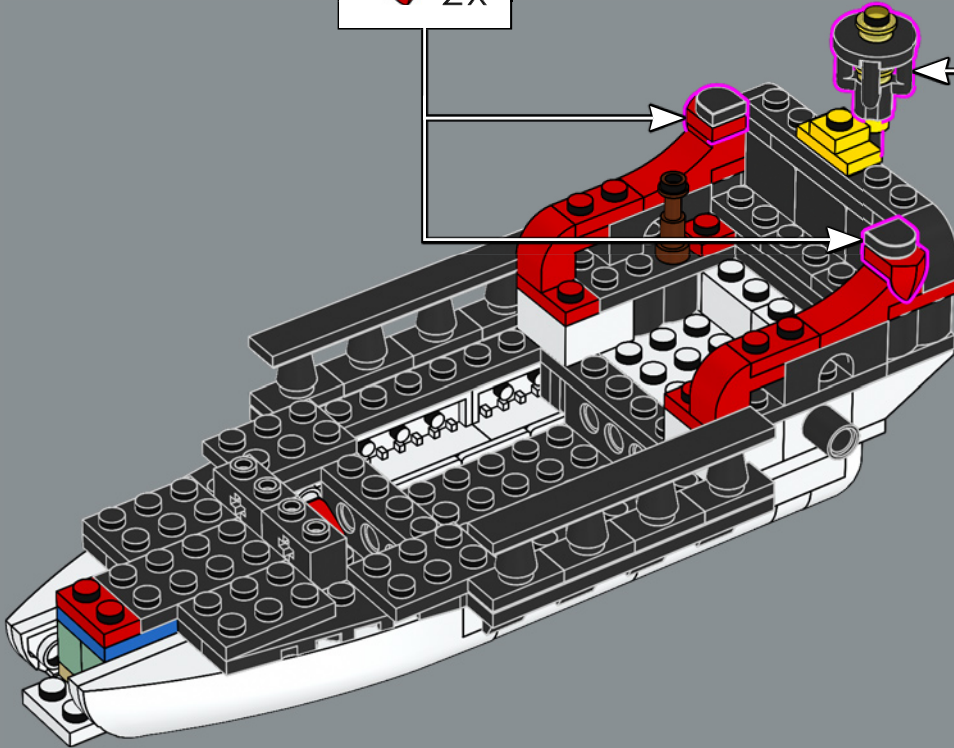
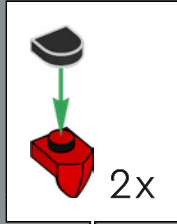
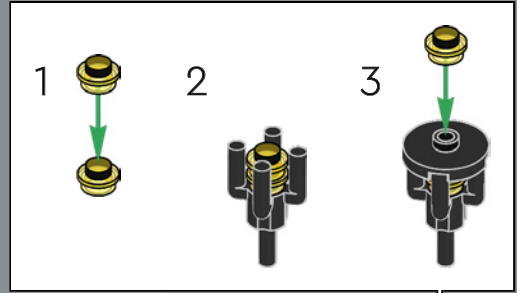

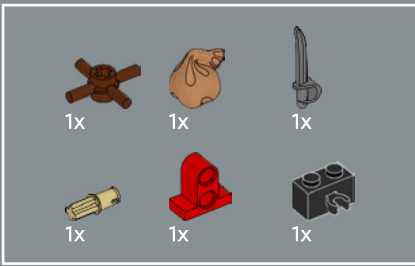

31

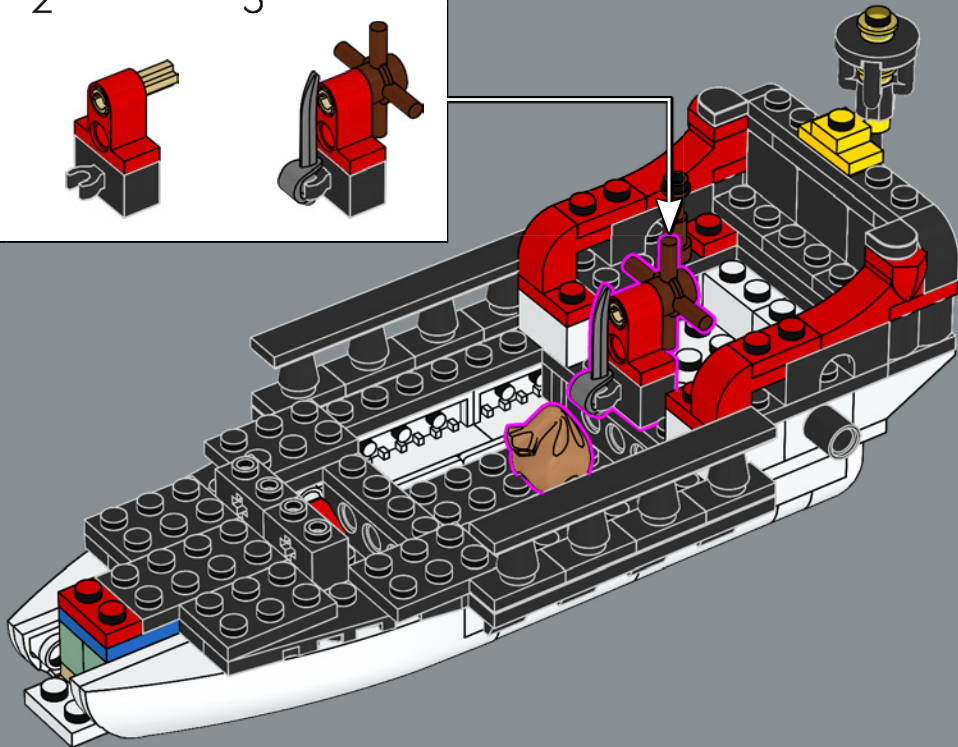
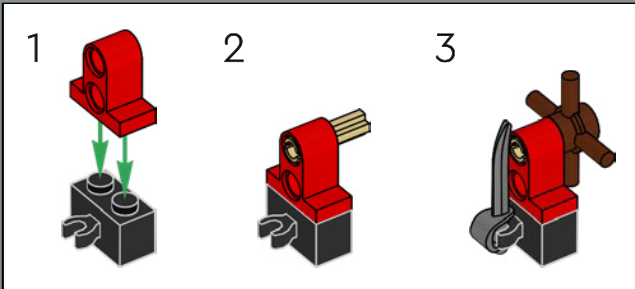

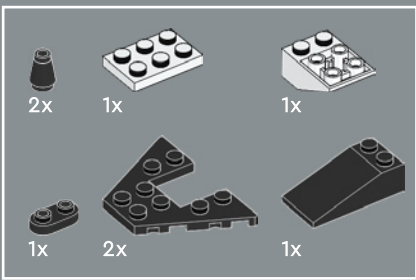

32

1

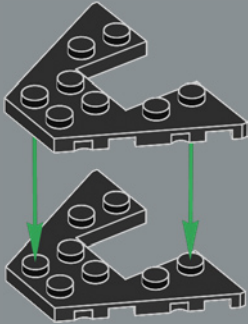

2

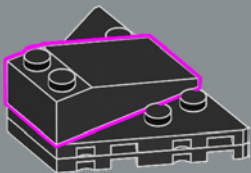

3

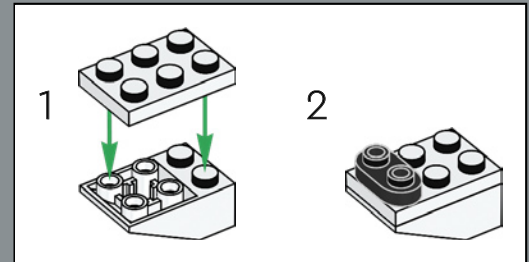
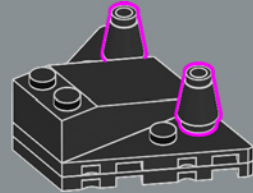

4

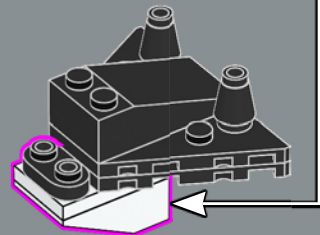

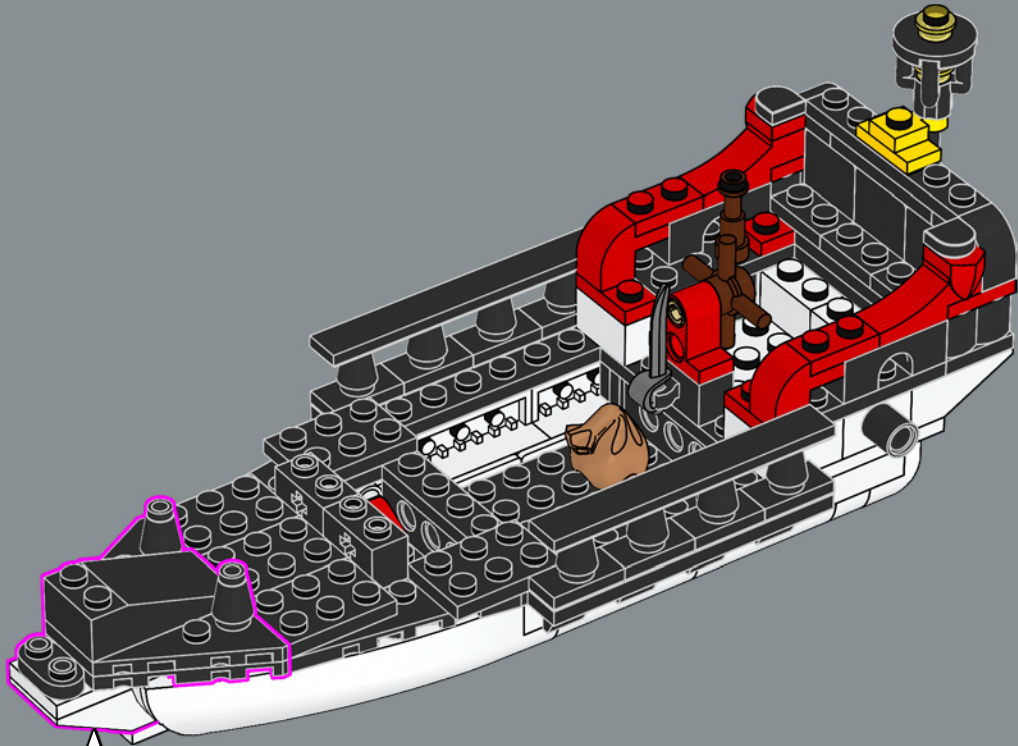

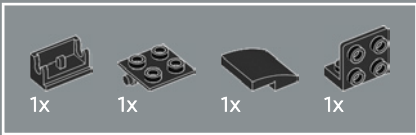

33

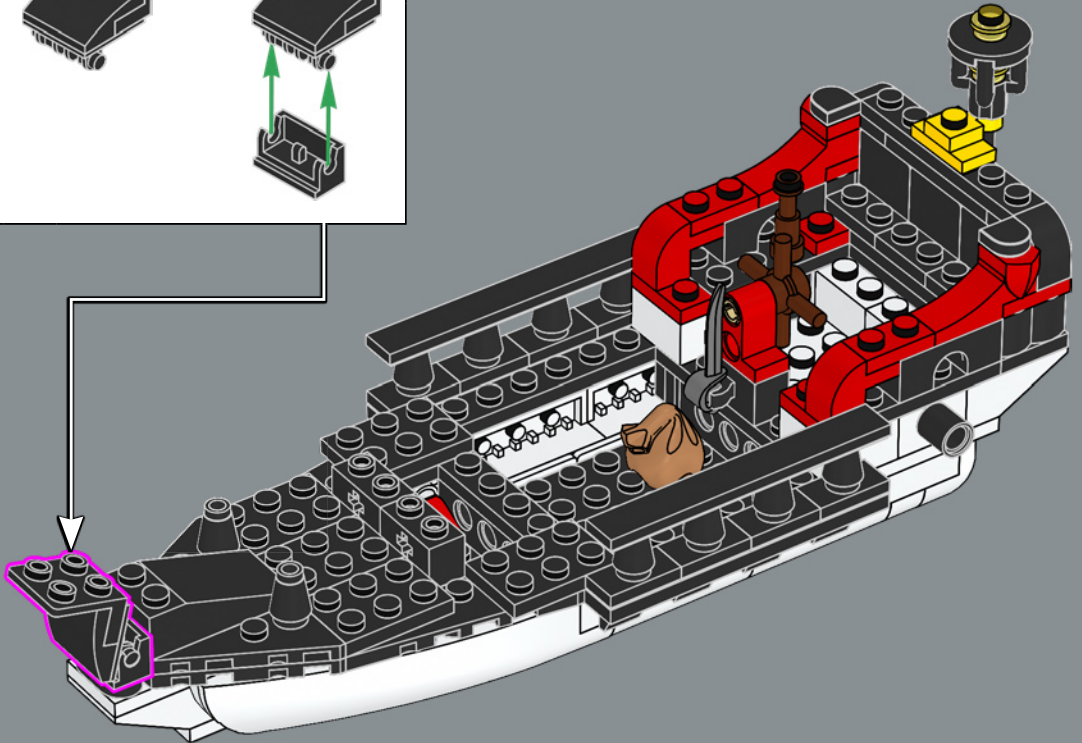
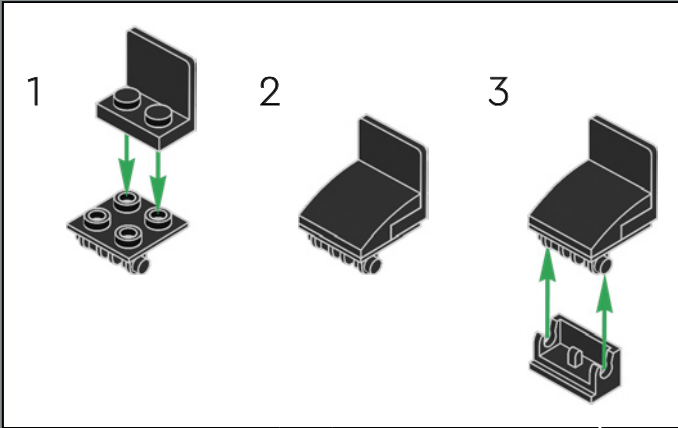

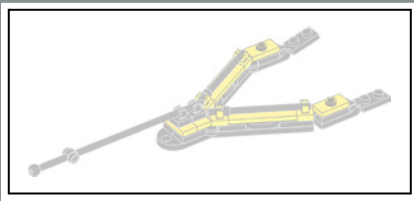

1x

34

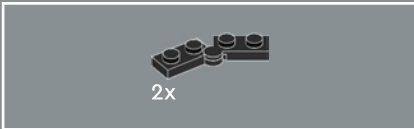

2x

35

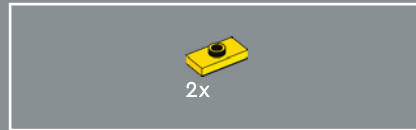
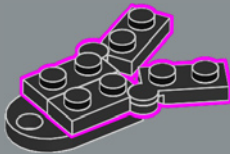

2x

36

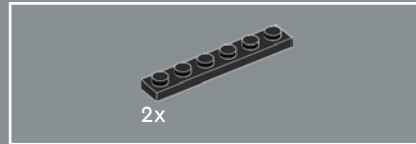
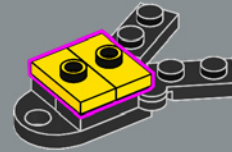

2x

37

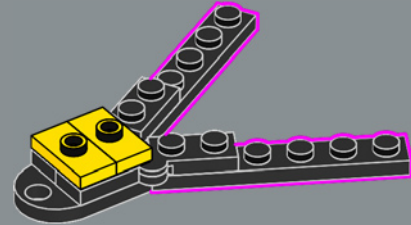



38

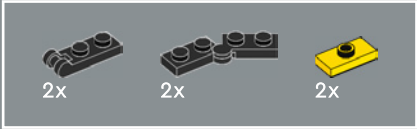
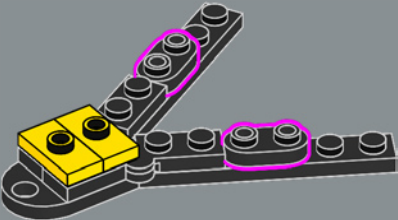

39

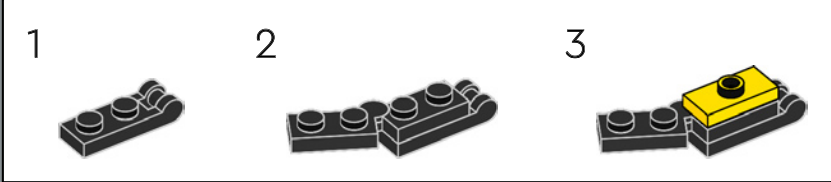
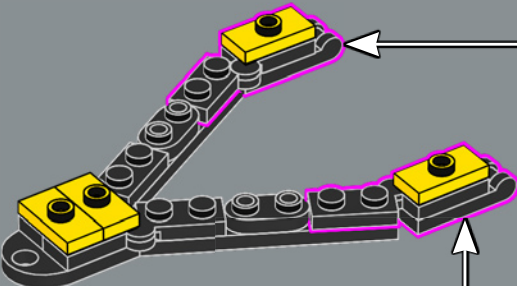
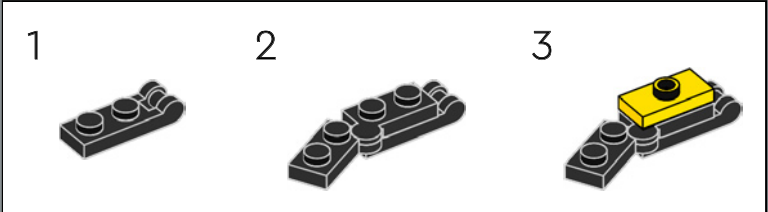

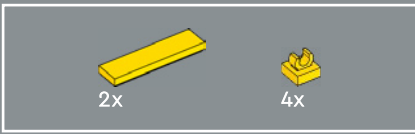

40

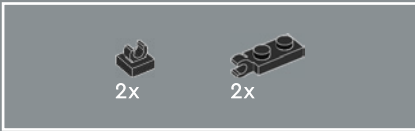
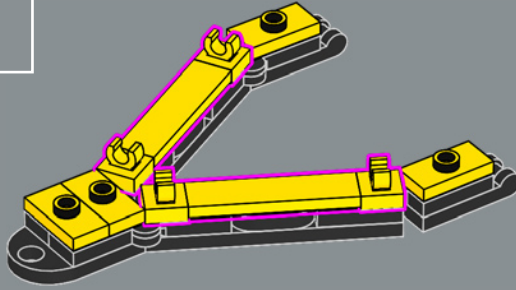

41

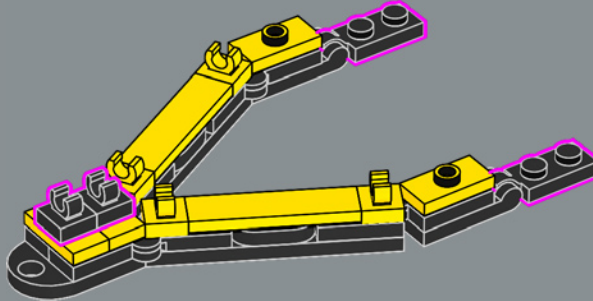

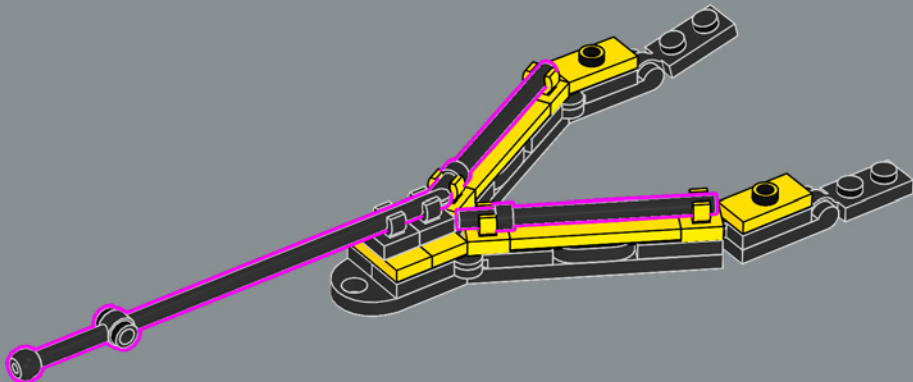
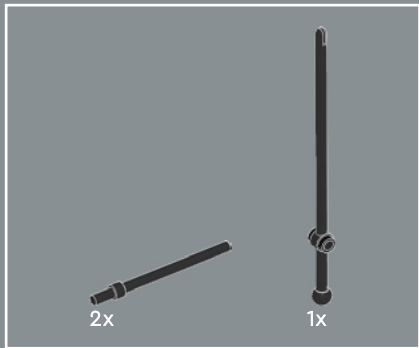

42

43

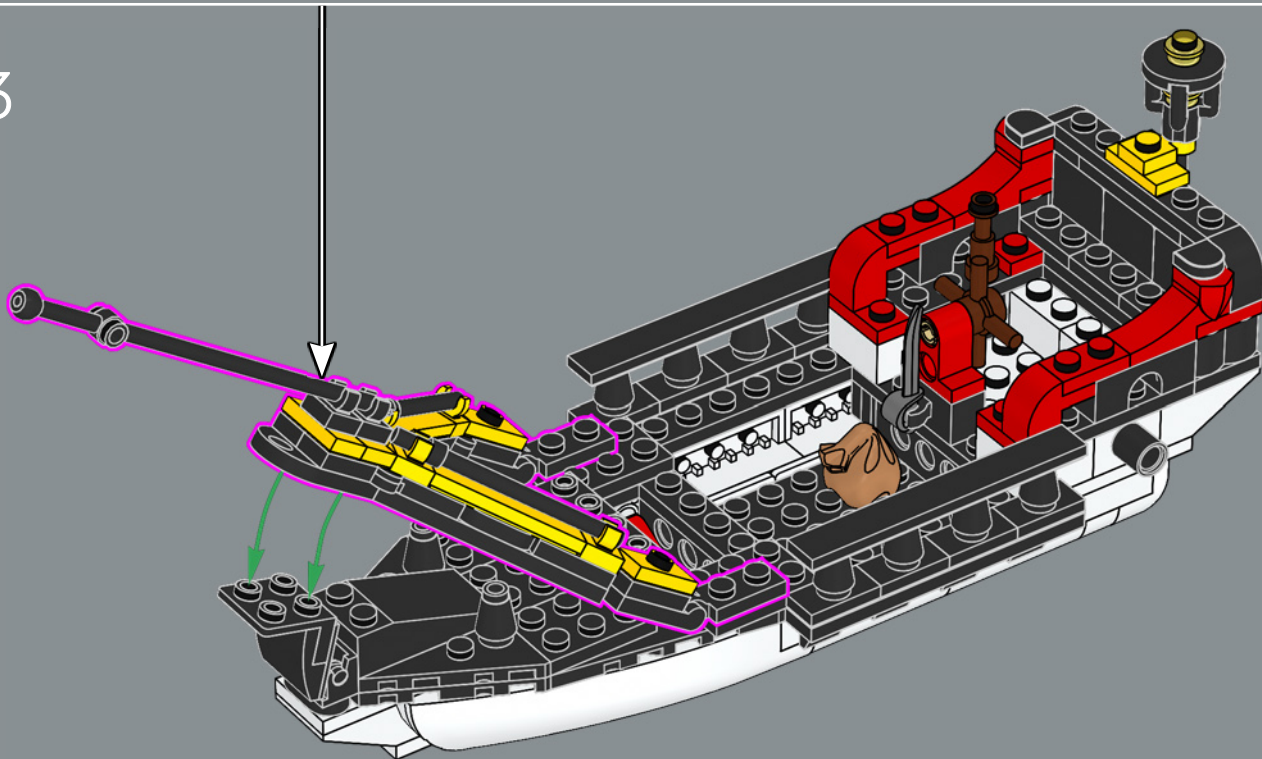

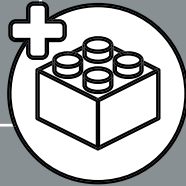
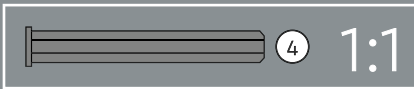
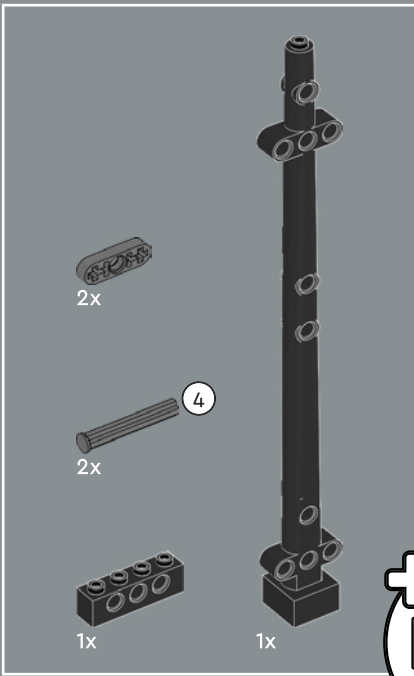

44

1

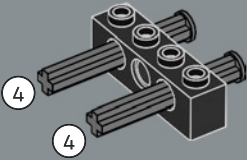

2

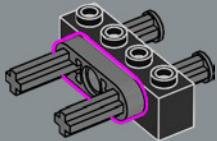

3

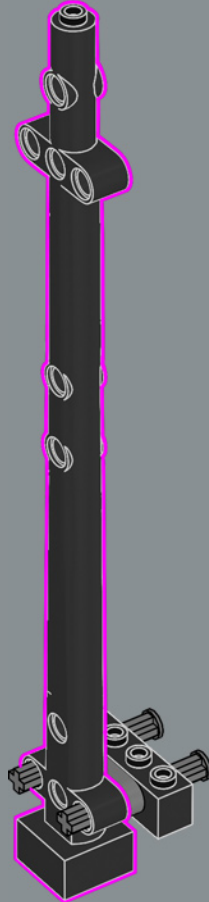

4

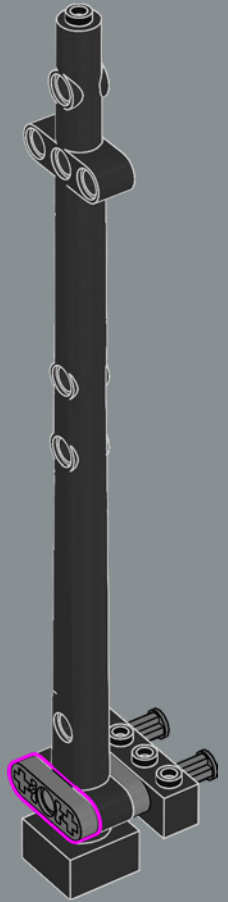

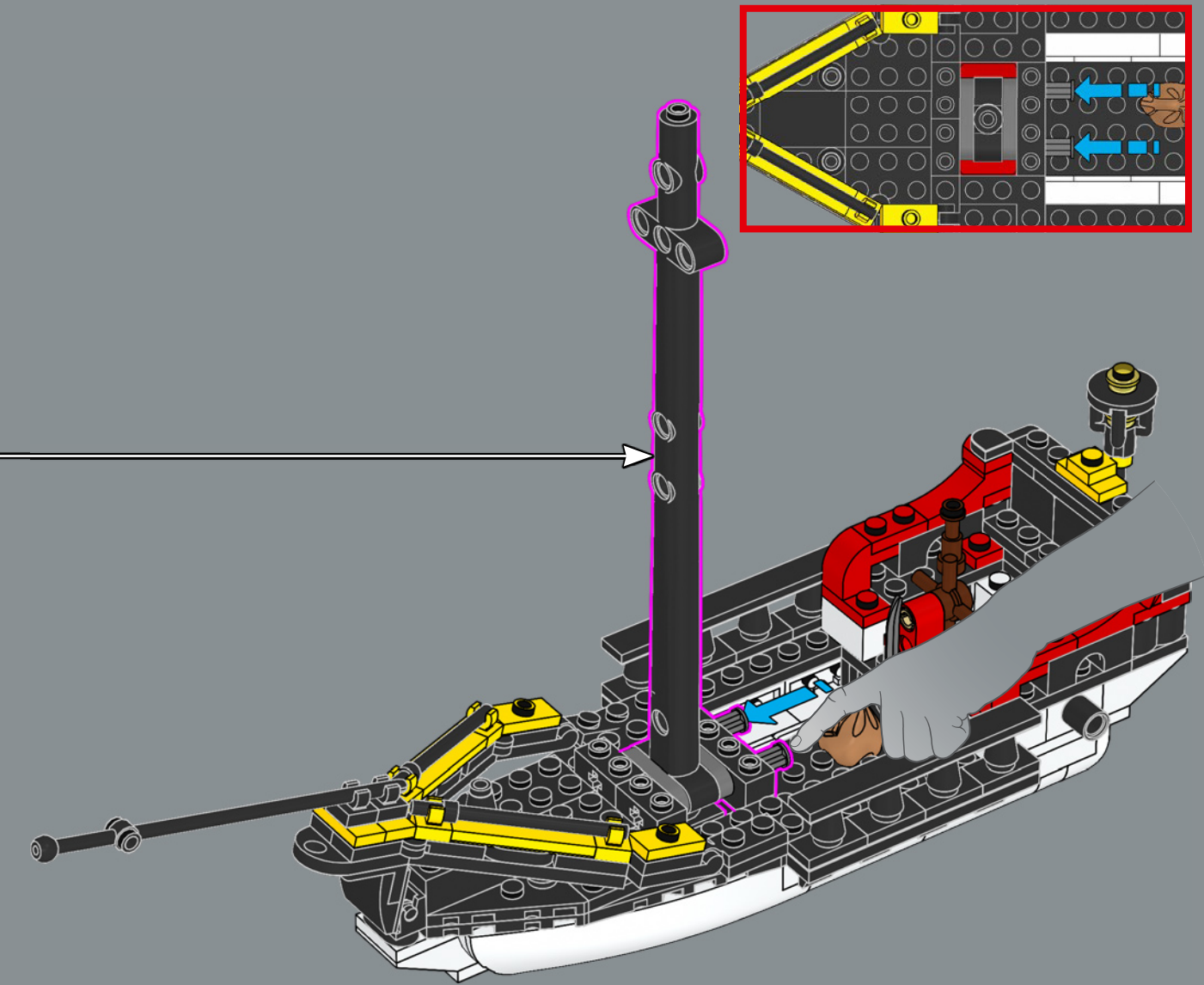



45

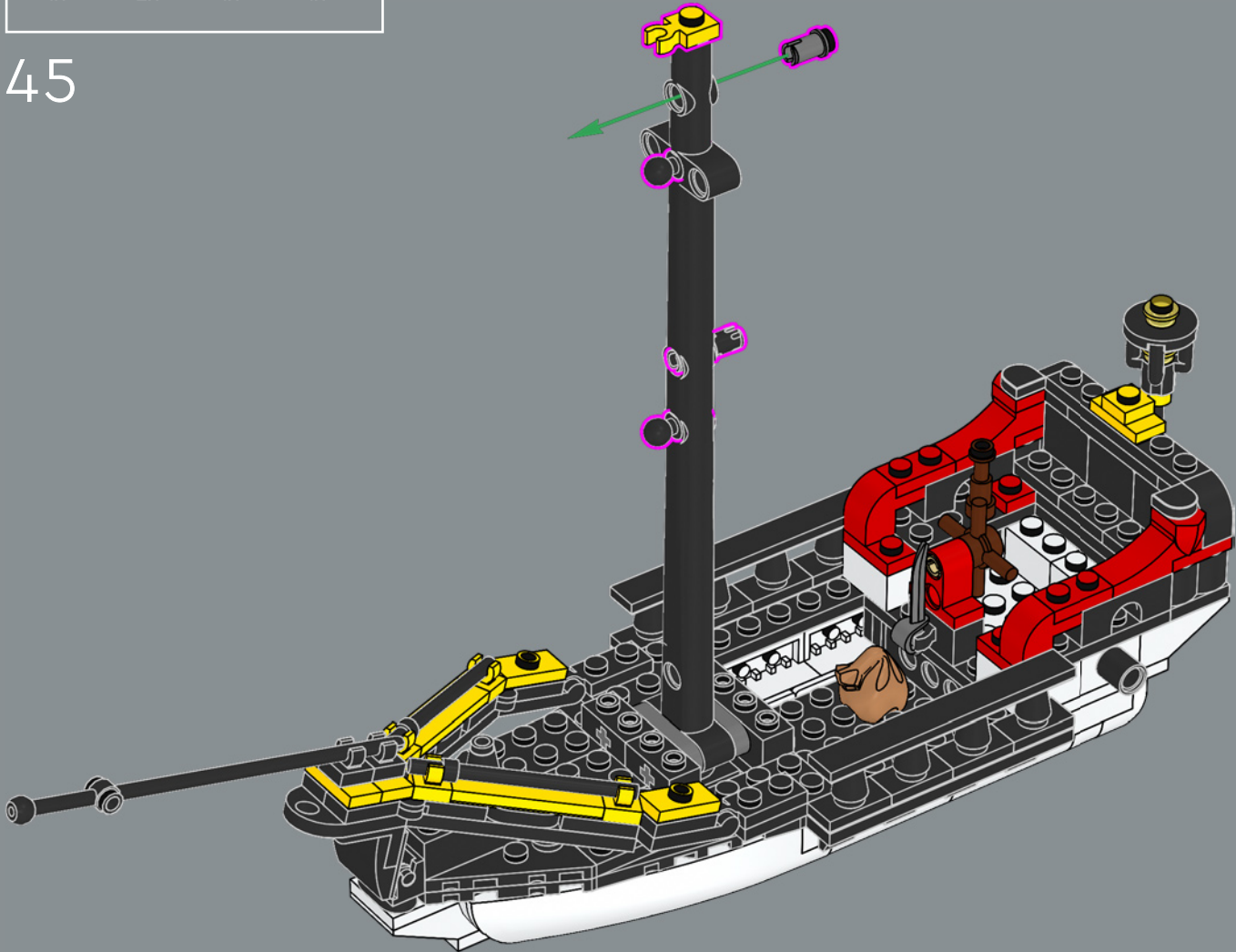

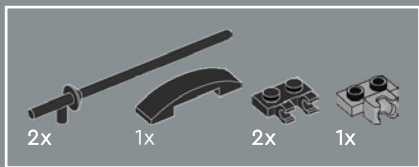

46

1

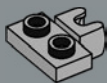

2

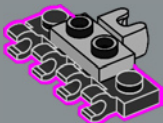

3

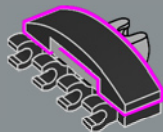

4

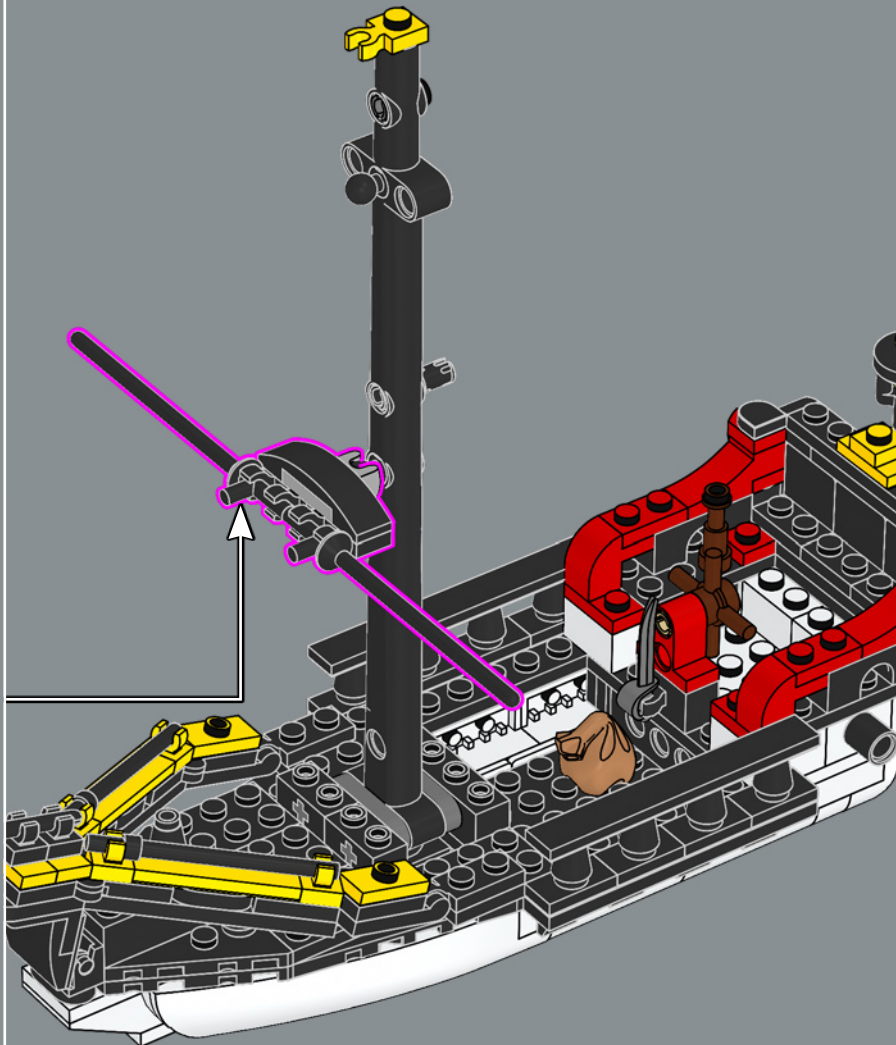
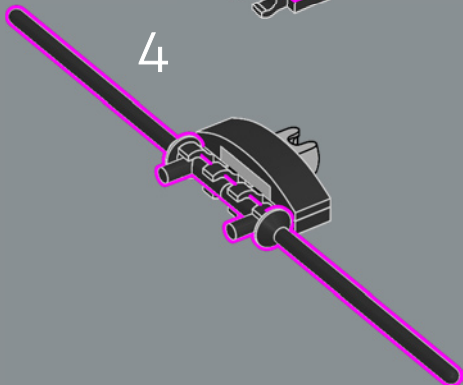

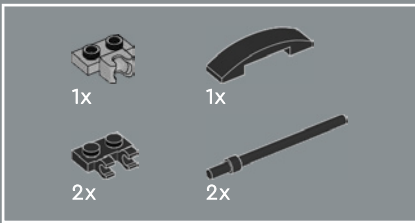

47

1

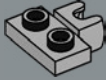

2

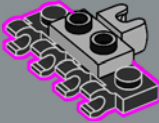

3

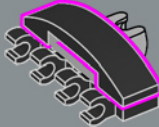

4

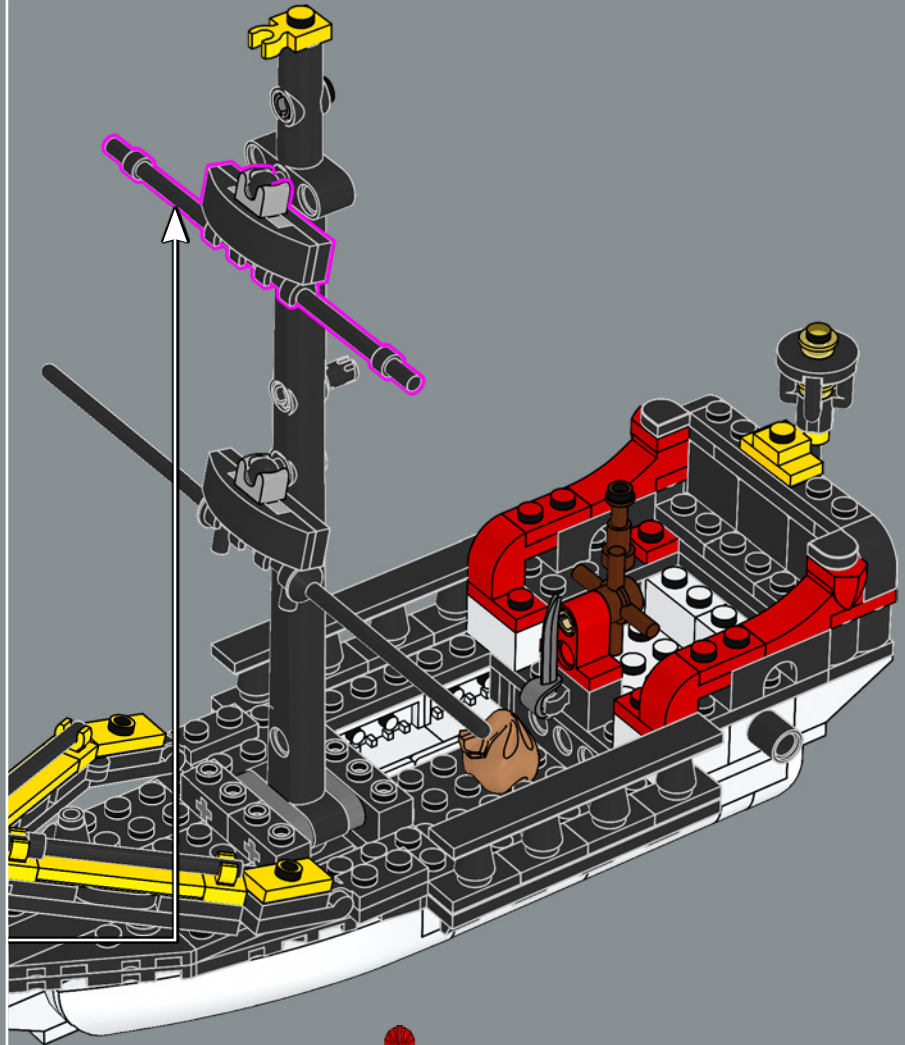
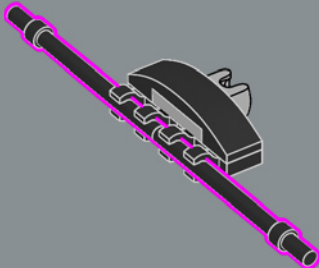



1x

48

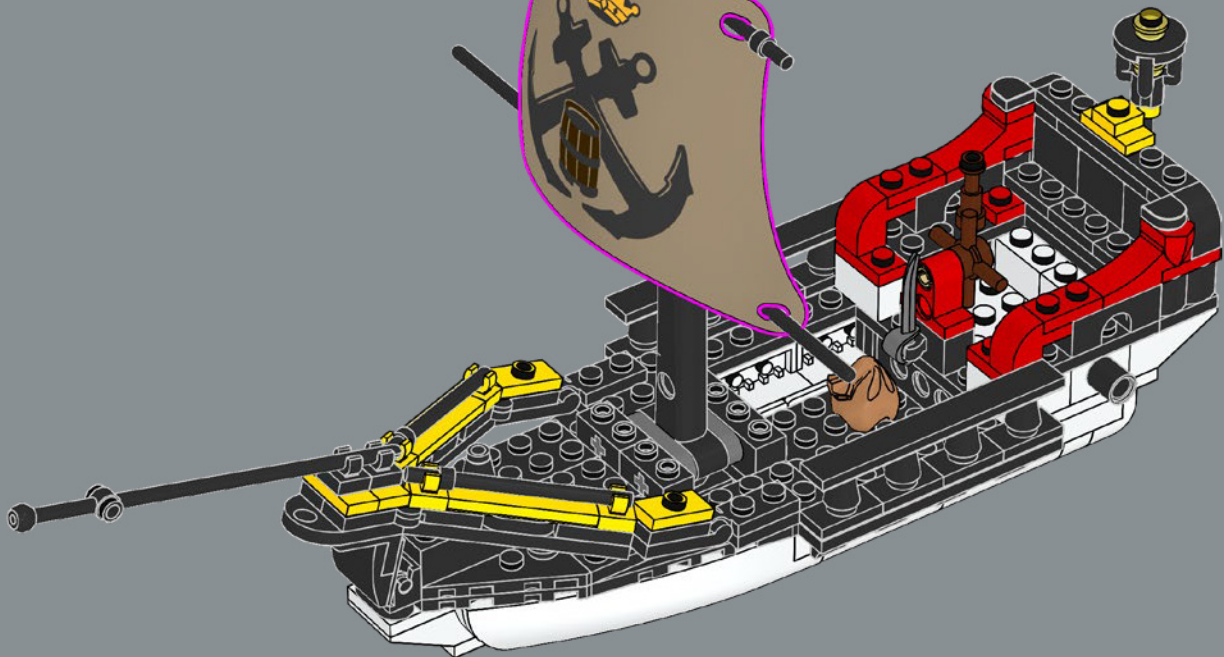
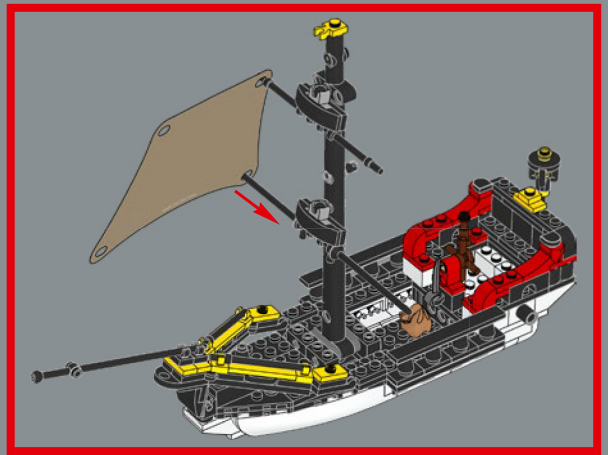
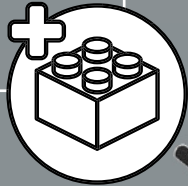

2x

49

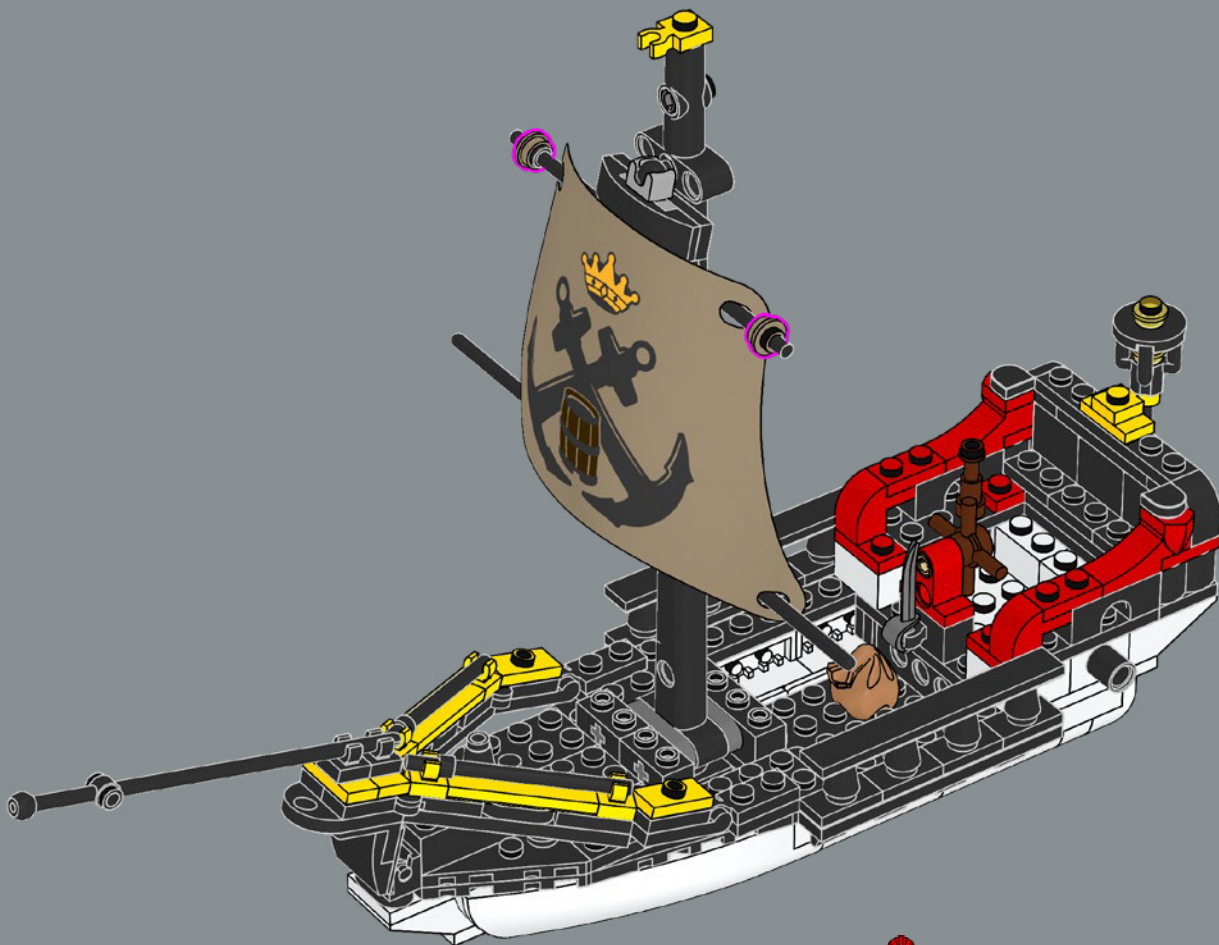

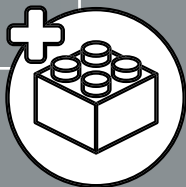
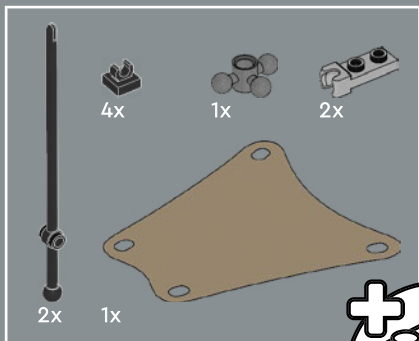

50

1



2

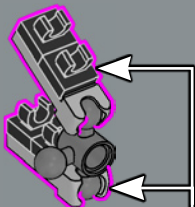

3

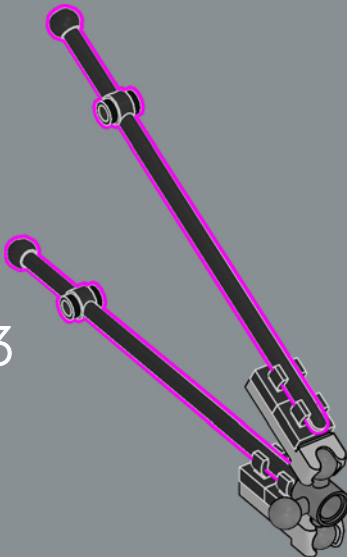

4

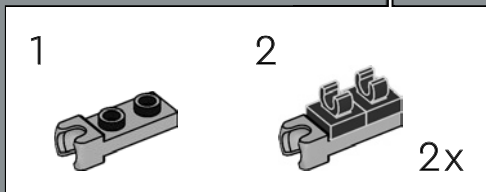
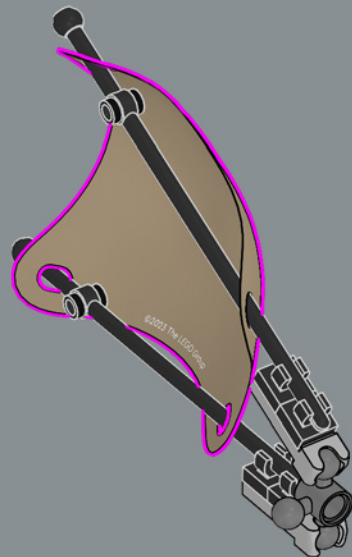

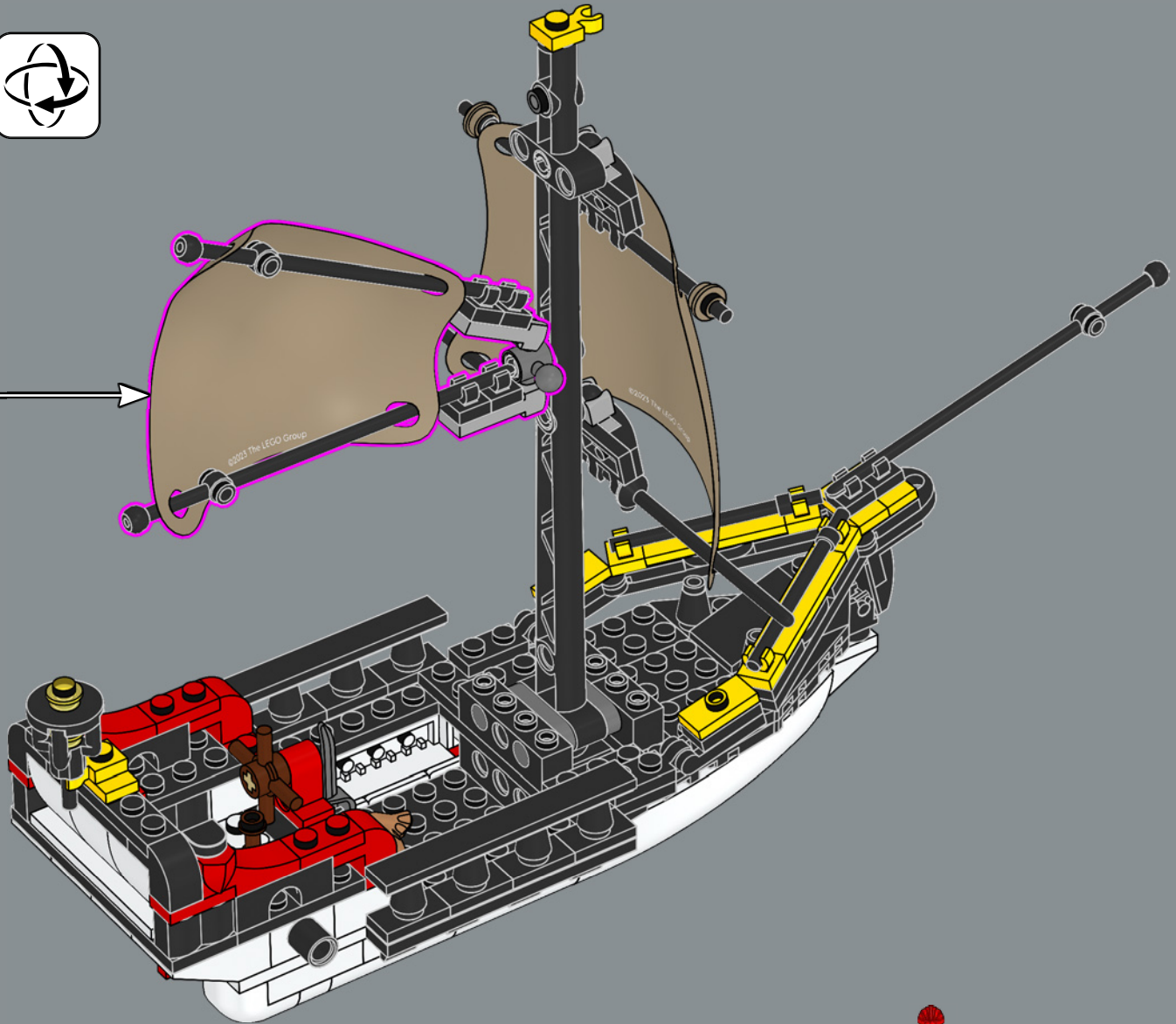

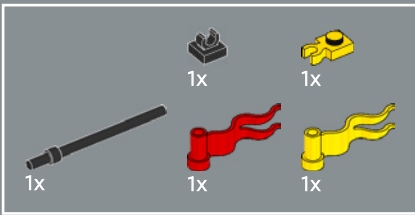

52

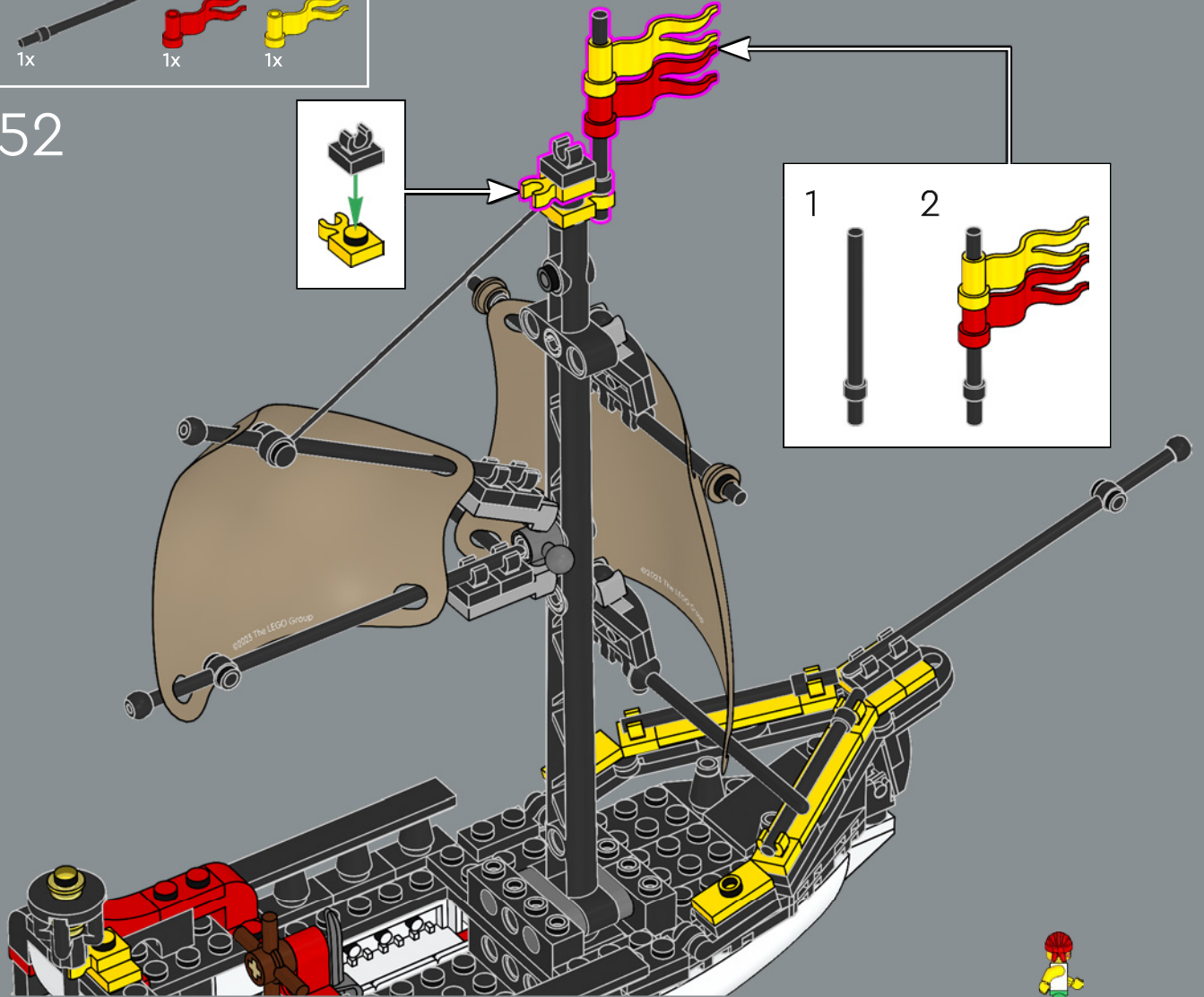
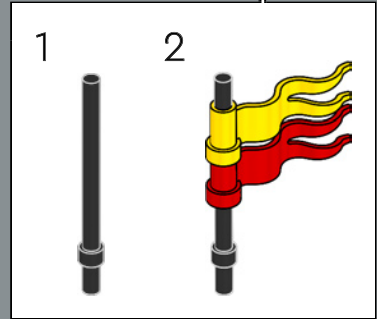
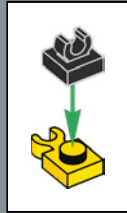

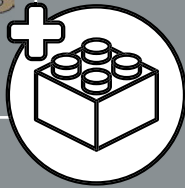
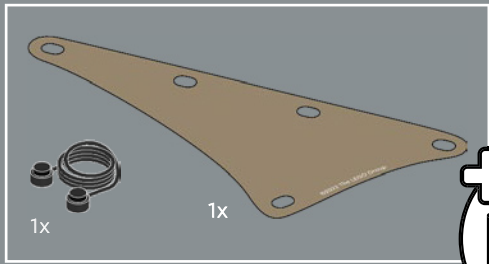

53

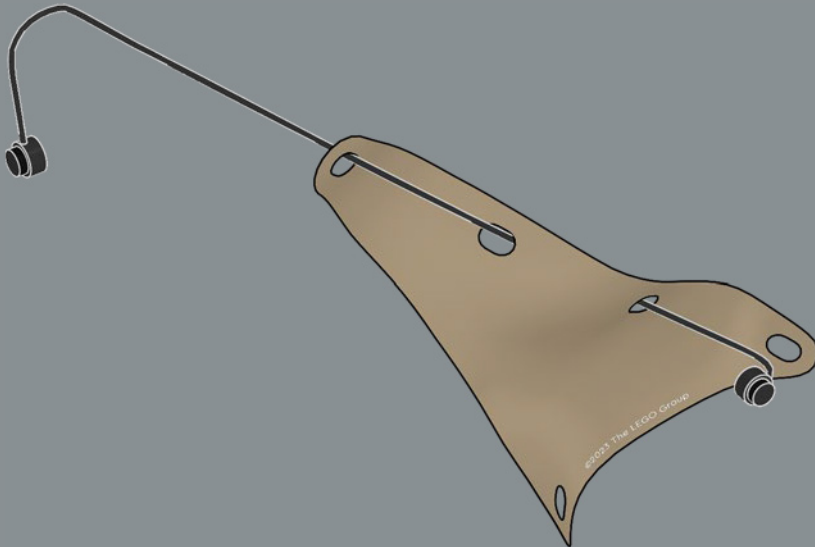

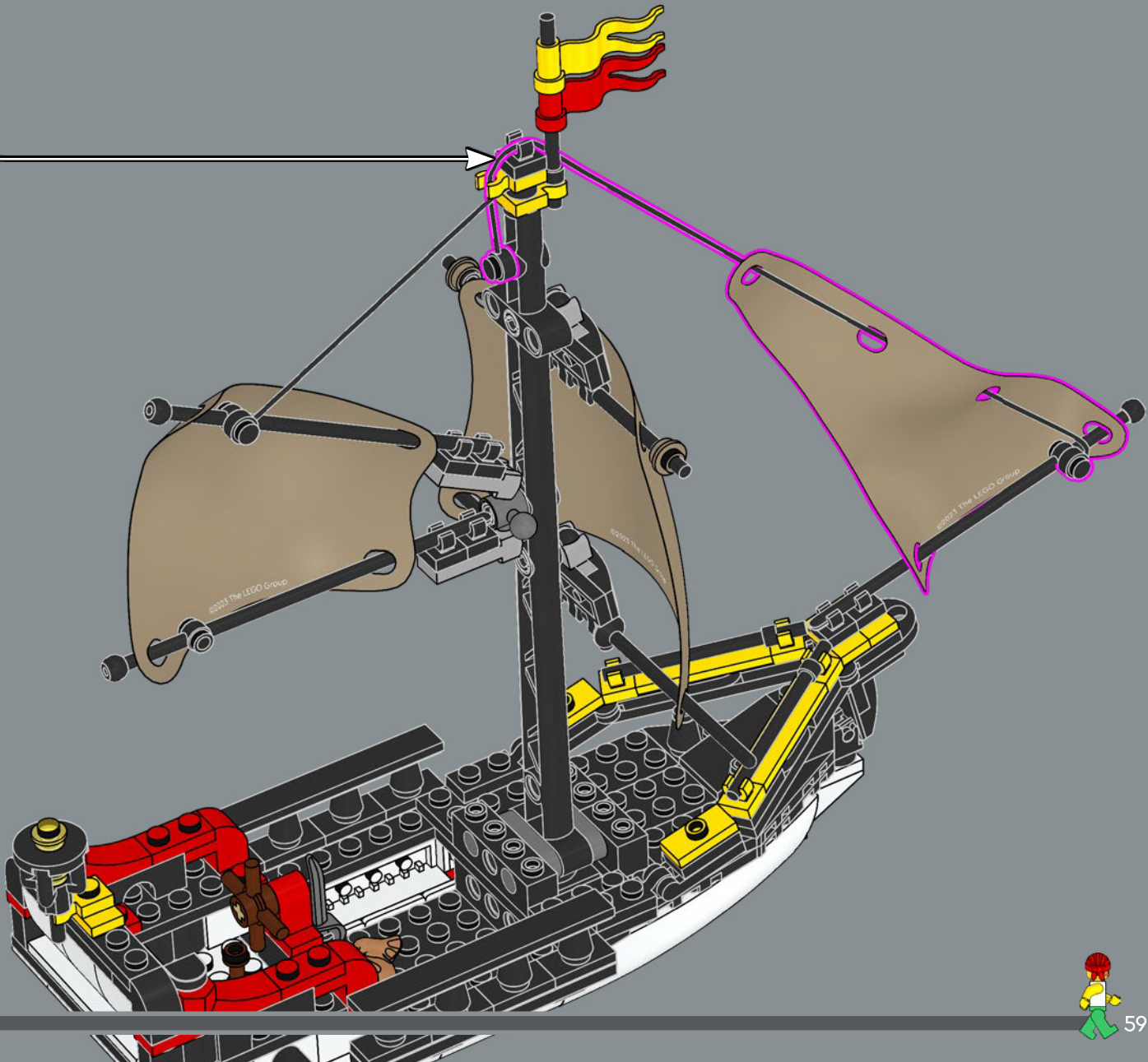



The original set featured two row boats. Well, times have changed – even for pirates – so larger ships can now dock at the pier.

L'ensemble original comprenait deux chaloupes. Les temps ont changé, même pour les pirates, et de plus grands navires peuvent désormais accoster à la jetée.

El set original incluía dos botes. Bueno, los tiempos han cambiado (hasta para los piratas) y ahora también pueden atracar en el muelle embarcaciones más grandes.

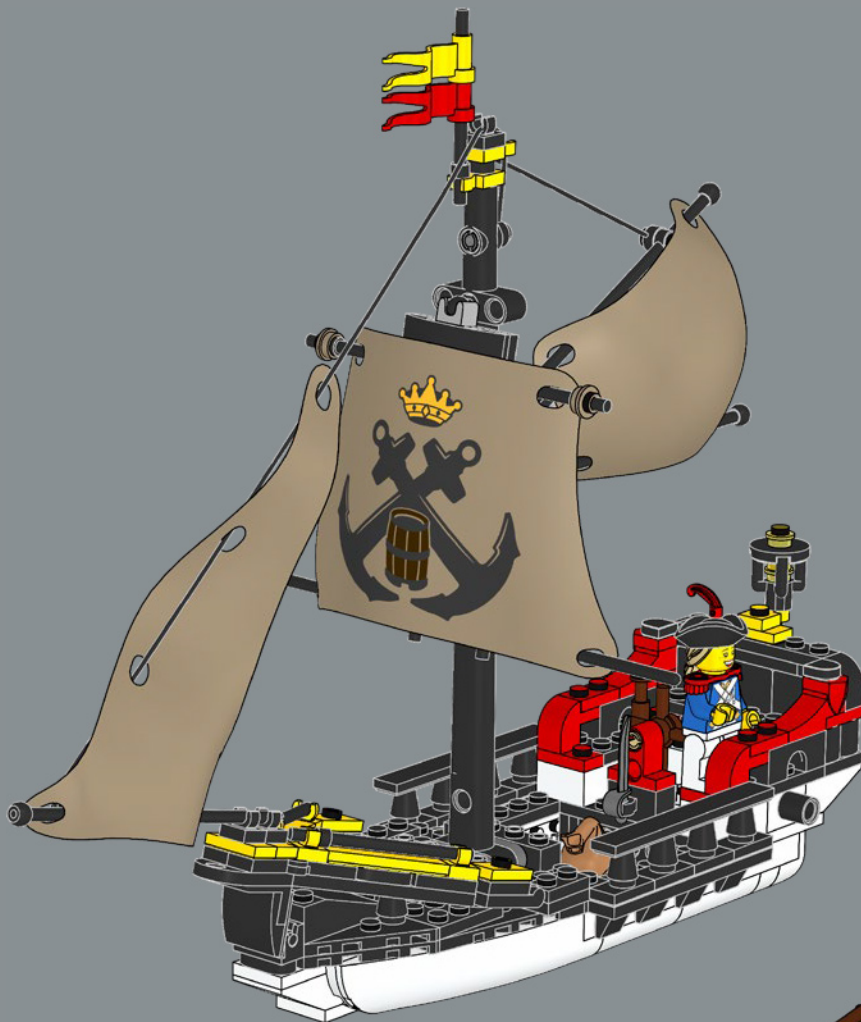

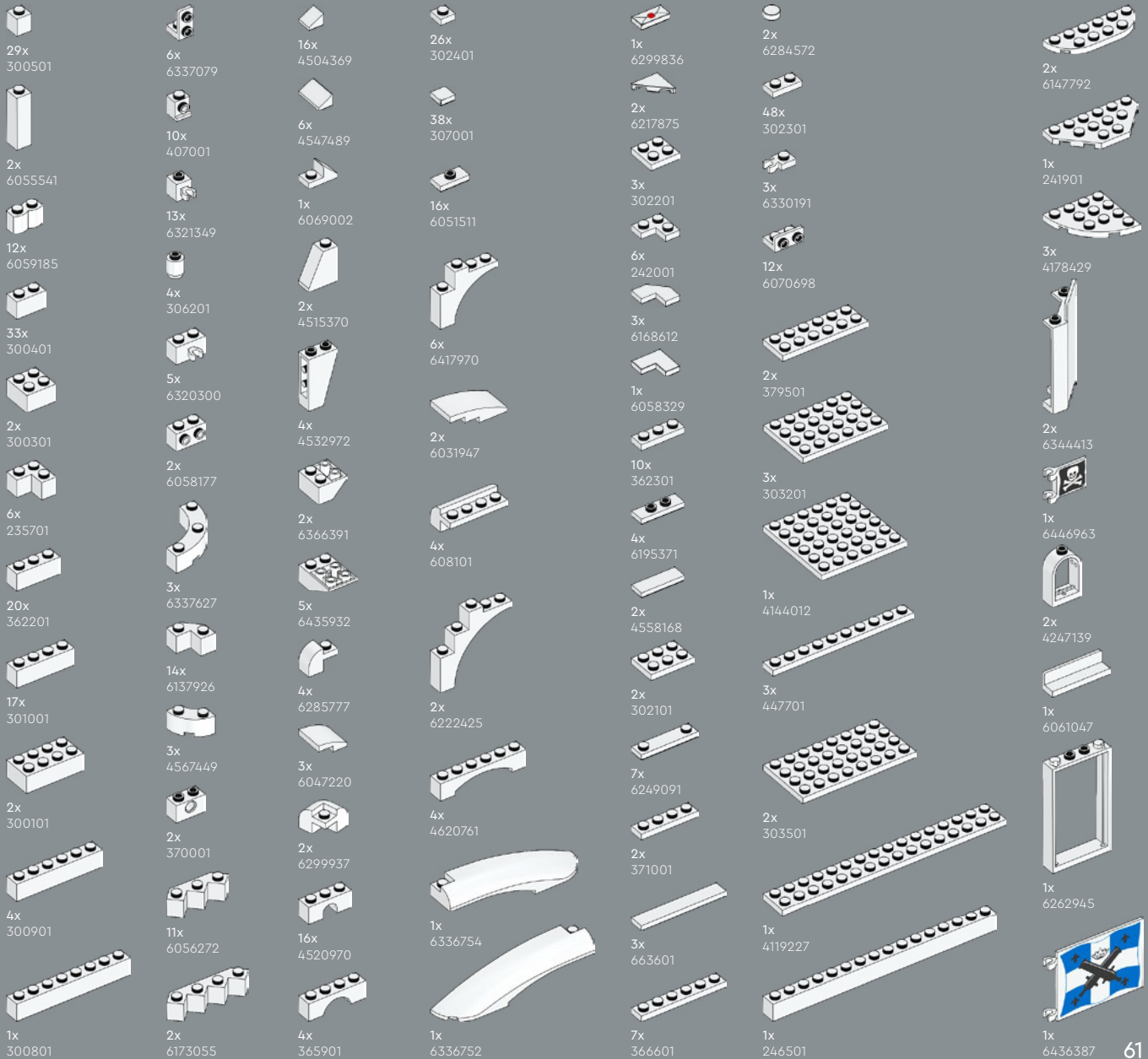



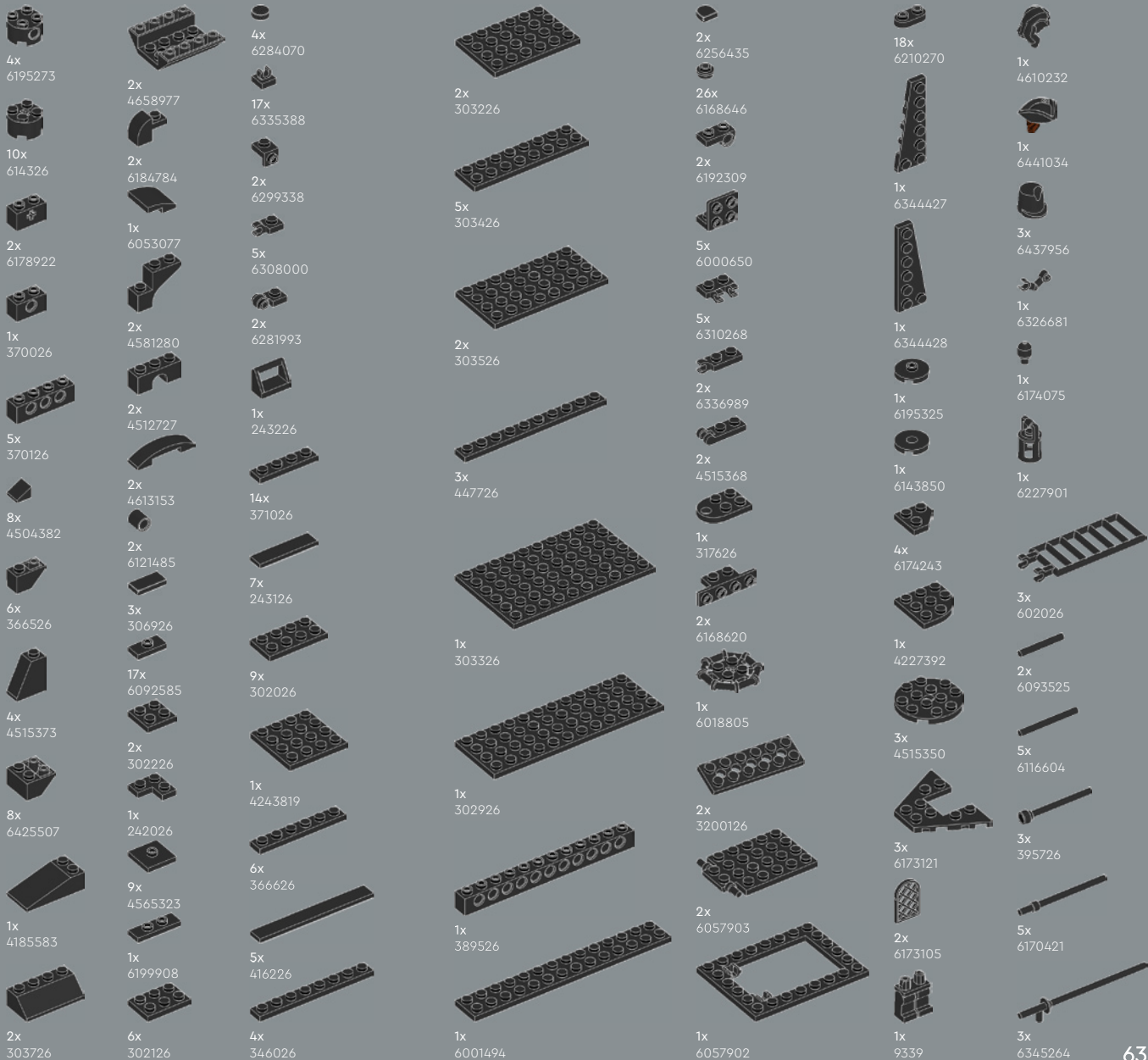

6

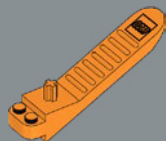
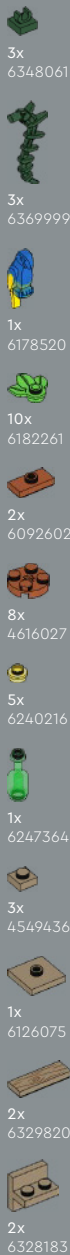

1x 6240515



2x 6300322



1x 6245275



1x 6343797



2x 6285249

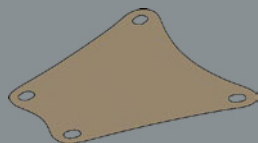

1x 6438800



1x 6438801

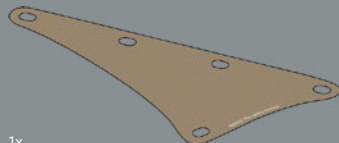

1x 6438799



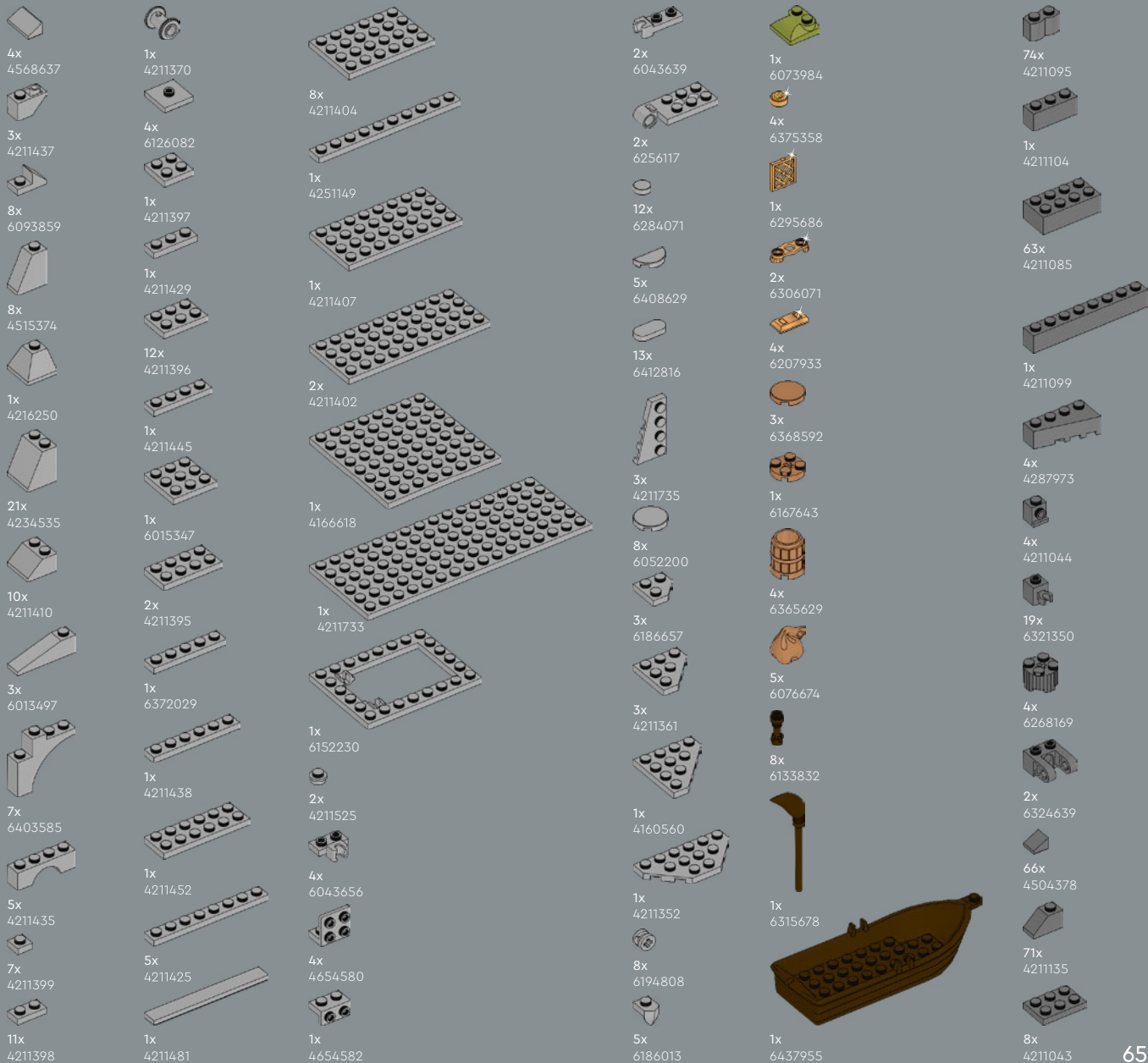



91x
4210702



33x
6000853



2x
4211045



1x
4298580



4x
6172811



2x
4620760



6x
6092572



8x
4211063



3x
4211094



1x
6309059



1x
4257526

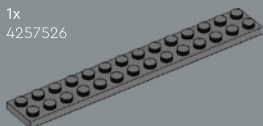

2x
6000970



3x
4211065



1x
4222042



17x
6362252



2x
6039479



3x
6013082



8x
6115080



6x
6205488



1x
6359227



2x
6338422



2x
6364452



1x
4520307



2x
4287814



2x
4211133



9x
6395635



1x
6347464



20x
6390673



2x
6083620



4x
6311445



2x
6344738



1x
6363146



1x
6037634



3x
6245795



2x
6335566



1x
4625032



2x
6233166



2x
6107389



1x
6249415

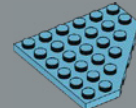

6x
6261503

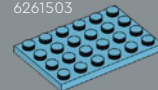

2x
4619515

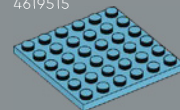

1x
6381912

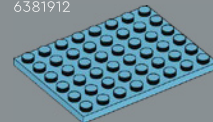

1x
6097036

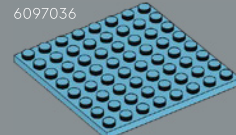

2x
6205088

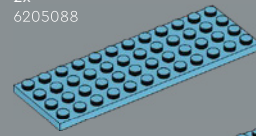

1x
6056270

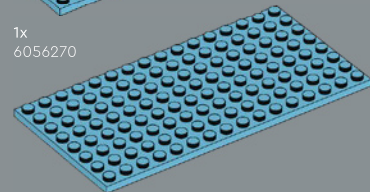

6x
6022010



[LEGO.com/service](https://www.LEGO.com/service)



YOU COULD WIN



YOU COULD WIN

Your feedback will help shape the future development of this product series.

Visit:

DU KÖNNTEST GEWINNEN

Dein Feedback trägt zur Weiterentwicklung dieser Produktreihe bei.

Geh auf:

VOUS POURRIEZ GAGNER

Vos commentaires nous aideront à concevoir les futurs produits de cette gamme.

Visitez :

POTRESTI VINCERE TU

La tua opinione ci aiuterà a migliorare la creazione futura di questa linea di prodotti.

Visita:

PUEDES GANAR

Tu opinión contribuirá al futuro de esta serie de productos.

Visita:

轻松获奖

您的反馈将有助于我们在今后改进本产品系列。

请访问：

LEGO.com/productfeedback

You also have the chance to win a LEGO® set.

Terms and conditions apply.*

Außerdem hast du die Chance, ein LEGO® Set zu gewinnen.

Es gelten die Teilnahmebedingungen.*

Vous pourriez également gagner un ensemble LEGO®.

Des conditions s'appliquent.*

Hai anche la possibilità di vincere un set LEGO®.

Termini e condizioni sono applicabili.*

También tienes la oportunidad de ganar un set LEGO®.

Aplican términos y condiciones.*

您还有机会赢取乐高®套装。

条款和条件适用。*

*LEGO.com/productfeedback-terms

